

Hybrid Wood and Steel Sole Plate Connection Walls to Floors Testing Report

RESEARCH REPORT RP03-4

2003

REVISION 2006



American Iron and Steel Institute



Steel Framing Alliance™

Steel. The Better Builder.

DISCLAIMER

The material contained herein has been developed by researchers based on their research findings and is for general information only. The information in it should not be used without first securing competent advice with respect to its suitability for any given application. The publication of the information is not intended as a representation or warranty on the part of the American Iron and Steel Institute, Steel Framing Alliance, or of any other person named herein, that the information is suitable for any general or particular use or of freedom from infringement of any patent or patents. Anyone making use of the information assumes all liability arising from such use.

PREFACE

This report was developed by the NAHB Research Center for the Steel Framing Alliance and the U.S. Department of Housing and Urban Development as part of a project on wood-to-steel hybrid connections. The objectives of this project were to compile, develop and test connection details illustrating recommended methods of joining cold-formed steel framing with wood framing to aid in the integration of wood and steel framing and, thereby, expand the use of steel in the residential market.

This portion of the project involved a series of tests to evaluate the capacity of 7 different wood-to-steel and 6 different steel-to-wood sole plate configurations. The findings were incorporated in the *Hybrid Wood and Steel Details – Builder’s Guide* and provided a basis for the AISI Committee on Framing Standards to allow the attachment of steel walls to the sub-floor sheathing without direct connection to floor joists in the *AISI Standard for Cold-Formed Steel Framing - Prescriptive Method for One and Two Family Dwellings*.

Research Team
Steel Framing Alliance

Hybrid Wood and Steel Sole Plate Connection Walls to Floors Testing Report

Prepared for

The U.S. Department of Housing and Urban
Development
Office of Policy Development and Research
Washington, DC

and

Steel Framing Alliance (SFA)
Washington, DC

by

NAHB Research Center, Inc.
400 Prince George's Boulevard
Upper Marlboro, MD 20774-8731

February 2003

Disclaimer

While the information in this document is believed to be accurate, neither the authors, nor reviewers, nor the U.S. Department of Housing and Urban Development, nor the Steel Framing Alliance, nor the NAHB Research Center, Inc., nor any of their employees or representatives make any warranty, guarantee, or representation, expressed or implied, with respect to the accuracy, effectiveness, or usefulness of any information, method, or material in this document, nor assumes any liability for the use of any information, methods, or materials disclosed herein, or for damages arising from such use.

Notice

The contents of this report are the views of the contractor and do not necessarily reflect the views or policies of the U.S. Department of Housing and Urban Development or the U.S. Government. The U.S. Government does not endorse producers or manufacturers. Trade and manufacturers' names appear herein solely because they are considered essential to the contents of this report.

Acknowledgements

This report was prepared for the U.S. Department of Housing and Urban Development (HUD) and the Steel Framing Alliance (SFA). Special appreciation is extended to Bill Freeborne of HUD and Kevin Bielat of the American Iron and Steel Institute (AISI) for their guidance and assistance throughout the project. The NAHB Research Center staff involved in this project are:

Project Manager	Jay P. Jones, PE
Technical Reviewer(s)	Vladimir Kochkin Nader R. Elhajj, PE
Lab Technician(s)	Stuart Denniston
Administrative Support	Lynda Marchman

The Research Center gratefully acknowledges the assistance of Joseph Marino of Dale/Incor for providing the steel used in the testing phase of this project.

Forward

The NAHB Research Center, U.S. Department of Housing and Urban Development (HUD) and the Steel Framing Alliance have worked cooperatively to introduce cold-formed steel framing into the residential construction market and to provide objective builders and homeowners with a cost-effective alternative construction material. To accomplish this objective, many barriers have been overcome. However, one of the remaining barriers is the lack of hybrid construction details giving builders the option of using steel or wood where it makes the most sense.

In response, HUD and the Steel Framing Alliance commissioned the NAHB Research Center to review existing details and develop a comprehensive list of hybrid wood and steel connection details. Details lacking engineering data required testing. One such detail was the hybrid wall-to-floor connection detail. This report is a summary of the testing procedures and results used to develop the hybrid wall-to-floor connection detail.

Alberto Faustino Trevino

Assistant secretary for
Policy Development and Research

Executive Summary

Cold-formed steel has been widely used in commercial buildings, especially in non-load bearing (partitions) and curtain wall applications. Cold-formed steel sections are increasingly being used as primary structural members, such as beams, floor joists, and load-bearing walls in commercial and residential construction.

Despite the availability of cold-formed steel framing, there are still basic barriers that impede its adoption in the residential market. Probably one of the primary barriers is that the building industry is generally reluctant to adopt alternative building methods and materials unless they exhibit clear quality or performance advantages. Therefore, builders tend to use alternative materials where it makes the most sense. Currently there is no single document that builders can use to construct hybrid cold-formed steel and wood homes. The available information and details for steel and wood hybrid structure are dispersed and not readily accessible to builders.

This report addresses hybrid, wall-to-floor connections, which include, the connection of wood walls to Cold-formed steel floors, and the connection of Cold-formed steel walls to wood floors.

The testing report on hybrid, wall-to-floor connections discusses important fastener characteristics, resistance requirements, and factors of safety. In addition, a complete test plan is presented along with the results and recommendations.

Table of Contents

	Page
Introduction.....	1
Background.....	2
Wall-to-Floor Connection Requirements.....	2
Factor of Safety.....	2
Fasteners	3
Experimental Approach	6
Wood Framed Wall to CFS Floor.....	6
Shear Test Specimens	6
Shear Testing Apparatus.....	7
Withdrawal Test Specimens	7
Withdrawal Testing Apparatus	8
Test Matrix.....	9
Results.....	9
Failure Modes	10
CFS Wall to Wood Frame Floor.....	11
Shear Test Specimens	11
Shear Testing Apparatus.....	12
Withdrawal Test Specimens	13
Withdrawal Testing Apparatus	13
Test matrix	14
Results.....	15
Failure Modes	15
Discussion.....	16
Recommendations.....	17
Conclusion	18
References.....	19

List of Tables

	Page
Table 1 - Fasteners and Connection Types	5
Table 2 - Wood-to-Steel Test Matrix.....	9
Table 3 - Wood-to-Steel Test Results Summary	9
Table 4 - Steel-to-Wood Test Matrix.....	15
Table 5 - Steel-to-Wood Test Results Summary	15
Table 6 - Fastener Schedule for Wood-to-Steel Connection	18
Table 7 - Fastener Schedule for Steel-to-Wood Connection	18

List of Figures

	Page
Figure 1 - Hybrid Wall-to-Floor Connections	1
Figure 2 - Loads Resisted by Sole Plate Connection.....	2
Figure 3 - Tested Fasteners for Hybrid Connections.....	4
Figure 4 - Shear Test Specimen for Wood-to-Steel Connections.....	6
Figure 5 - Shear Test Specimen in UTM.....	7
Figure 6 - Withdrawal Test Specimens for Wood-to-Steel Connections	8
Figure 7 - Withdrawal Test Specimen in the UTM	8
Figure 8 - Typical Shapes of Shear Test Curves.....	10
Figure 9 - Typical Shapes of Withdrawal Test Curves.....	11
Figure 10 - Shear Test Specimen	12
Figure 11 - Shear Test Specimen in UTM.....	12
Figure 12 - Withdrawal Test Specimen	13
Figure 13 - Withdrawal Test Specimen in UTM	14
Figure 14 - Displacements Measured in Withdrawal Tests.....	14
Figure 15 - Fastener Locations for Steel-to-Wood Withdrawal Tests.....	16
Figure 16 - Effect of Lateral Restraint on Shear Tests	17
Figure 17 - Laterally Restrained and Unrestrained Test Results	17

Introduction

Light gauge, cold-formed steel (CFS) is becoming a popular alternative to wood framing in the residential housing market, especially in areas where increased fire and decay resistance are desired. In the past, homes have either been framed entirely with steel or entirely with wood, but recently, builders have begun to integrate CFS framing with wood framing to take advantage of certain desired qualities unique to each of the materials. The use of CFS and wood framing together, referred to as hybrid construction, is a growing practice, although it is not specifically addressed in the model codes. Therefore, since hybrid details are not readily available, builders must rely on good judgment or designers to address certain structural details.

A common hybrid construction practice is to use wood framed walls and CFS floors, or in some cases, CFS walls and wood framed floors. The connection of these two building components (wall and floor) is important to the overall structural integrity of a home. Lateral resistance is provided by the fasteners along the sole plate of the wall, and uplift resistance is typically addressed with separate hardware. Prescriptive methods are available in model codes for wood wall to wood floor connections, and also for steel wall to steel floor connections, but do not exist for hybrid connections. In addition, the NDS[1][2] does not address this specific wood-steel configuration for a theoretical solution.

The purpose of this study is to gain the information necessary to develop prescriptive methods for connecting wood framed walls to CFS floor systems, and for connecting CFS walls to wood framed floors (see Figure 1). Testing will be done to determine the shear and uplift capacity of practical, hybrid, wall-to-floor connections. This study involves testing of common sized framing components (stud walls and sheathed floor joists) connected with fasteners that are readily available in the wood and steel trades (i.e., screws and nails).

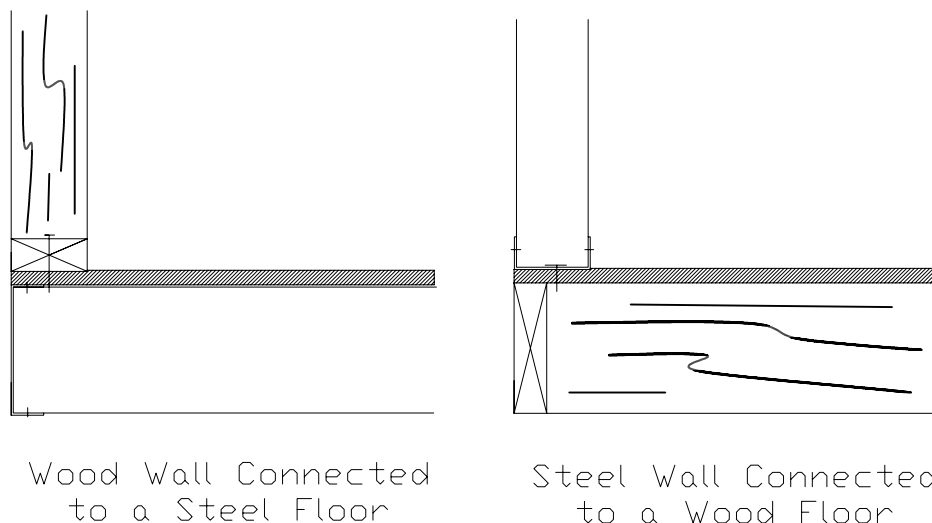

FIGURE 1
HYBRID WALL-TO-FLOOR CONNECTIONS

Background

WALL-TO-FLOOR CONNECTION REQUIREMENTS

The connection between the wall and floor platform provides lateral shear resistance in directions parallel and perpendicular to the wall (see Figure 2). The parallel connection resists shear loads transferred from the walls, whereas the perpendicular connection resists inward and outward wind pressure acting on the face of the wall.

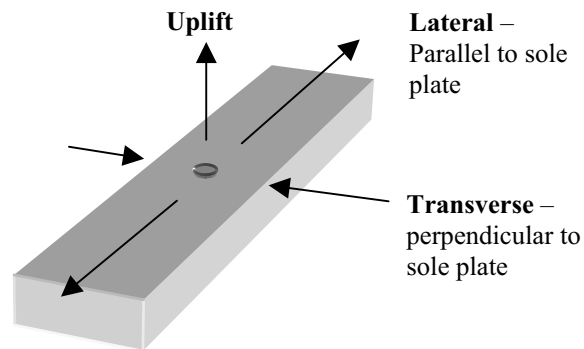

FIGURE 2
LOADS RESISTED BY SOLE PLATE CONNECTION

The NDS[1][2] does not require shear values for wood screws and nails to be adjusted for varying grain direction with respect to load directions (i.e., load parallel to grain or load perpendicular to grain). Lateral fastener strength for any load-to-grain angle can be adequately predicted by testing in one direction. Testing in this study was done with loading parallel to grain to establish values for both directions.

In an engineered design, sole plate fasteners are rarely relied on for uplift resistance. Separate brackets or straps are typically used for wind uplift connections and shear wall holdowns. However, in conventional construction, where prescriptive methods are used, these fasteners must contribute to the uplift resistance. Therefore, fastener withdrawal tests were also included in this study.

FACTOR OF SAFETY

The nominal fastener design value (R) can be determined by applying an appropriate factor of safety to average ultimate test values:

$$R = \frac{R_n}{\Omega} \quad \text{where } R_n = \text{average value of all test values}$$
$$\Omega = \text{factor of safety}$$

The AISI [3][4] specifies a factor of safety (Ω) for screwed connection as:

$$\Omega = \frac{1.6}{\phi}$$

where ϕ = Resistance Factor

$$= C_{\phi} (M_m F_m P_m) e^{-\beta_0 \sqrt{V_M^2 + V_F^2 + C_P V_P^2 + V_Q^2}}$$









where:

- C_{ϕ} = Calibration coefficient = **1.52**
- M_m = Mean value of the material factor = **1.10** (All connections)
- F_m = Mean value of the fabrication factor = **1.00**
- P_m = Mean value of the professional factor for the tested component = **1.0**
- β_0 = Target reliability index = **3.5** (connections)
- V_M = Coefficient of variation of the material factor = **0.10**
- V_F = Coefficient of variation of the fabrication factor = **0.15**
- C_P = Correction factor
- $= \frac{(1 + \frac{1}{n})m}{(m-2)}$ for $n \geq 4$, and 5.7 for $n = 3$
- n = Number of tests
- V_P = Coefficient of variation of the test results (from test results)
- m = Degree of freedom = $n - 1$
- V_Q = Coefficient of variation of the load effect = **0.21**

A factor of safety, based on the number of tests and corresponding coefficient of variation, was calculated for each shear test set (see Appendix B). The average factor of safety for all shear test sets was approximately 3.6. The recommended design shear values presented in this report are based on a factor of safety of 3.6 applied to average ultimate loads. The proposed design values for withdrawal in this report are based on one fifth of the average ultimate test values, which is consistent with nail withdrawal design values used in wood construction [2].

FASTENERS

Fasteners used for hybrid connections must have qualities that will; (1) prevent head pull through, (2) limit gaps between connected materials, (3) provide thread grip, and (4) easily penetrate the materials. Characteristics, such as head type, length, and point style, will vary depending on the type and thickness of the substrate. Several fastener types were included in this connection study (see Figure 3). The tested fasteners were selected based on product availability and suitability for the application. Seven different screw types and one nail type were tested.

FASTENERS	
Ref # 1 .131" x 3.25" pneumatic nail (un-coated) 	Ref # 5 #8 x 3" self-drilling, bugle head 
Ref # 2 #8 x 3" self-tapping, flat head 	Ref # 6 #8 x 1.5" self-piercing, wafer head (fully threaded) 
Ref # 3 #10 x 3" self-tapping, flat head 	Ref # 7 #8 x 1-5/8" self-drilling, wafer head (fully threaded) 
Ref # 4 #8 x 3" self-piercing, wafer head (partially threaded) 	Ref # 8 #10 x 2.5" self-drilling, pan head (fully threaded) 

**FIGURE 3
TESTED FASTENERS FOR HYBRID CONNECTIONS**

The fastener types for the various hybrid configurations were chosen based on their ability to penetrate through the materials, and effectiveness once installed. Countersinking heads were used when wood was attached to steel, and low profile heads were used when steel was attached to wood. Self-drilling points were used when wood was attached to steel, and self-piercing points (sharp points) were used when 33 mil steel was attached to wood, although self-drilling points were needed when thicker steel was used. The following section describes screw characteristics, and Table 1 lists the fasteners that were used in the various hybrid configurations.

Screw Point Types

- Self-tapping point – Used for the wood-to-wood connections only (i.e., wood sole plate to OSB). This type of point cannot be used in the steel connections without a pre-drilled hole. (See Figure 3, fastener reference numbers: 2 and 6.)
- Self-drilling point – Used for the wood-to-steel connections. This point is designed to bore through the wood, and then cut through the steel. The threads engage in the steel and pull the materials (wood and steel) together. The threads are ineffective in the connected wood member; so the head is relied on to prevent uplift. (See Figure 3, fastener reference numbers: 5, 7 and 8.)
- Self-piercing point – Used for steel track to wood floor connections when a 33 mil track is used. The point is designed to penetrate through 33 mil steel or thinner without needing a pre-drilled hole. (See Figure 3, fastener reference numbers: 4 and 6.)

Screw Head Types

- Flat head – Used for the wood-to-wood connections. This head type is countersinking and characteristic to wood screws. (See Figure 3, fastener reference numbers: 2 and 3.)
- Bugle head – Used for the wood-to-steel connections. This head type is also countersinking and similar to the flat head wood screw but has a curved transition from the shaft to the head. This is a common head type for sharp point screws. (See Figure 3, fastener reference number: 5.)
- Wafer head – Used for the steel-to-wood connections. The head has a low profile and flat underside. This is not a countersinking head and is suitable for steel-to-steel connections or steel-to-wood connections. (See Figure 3, fastener reference numbers: 4, 6 and 7.)

**TABLE 1
FASTENERS AND CONNECTION TYPES**

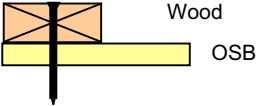
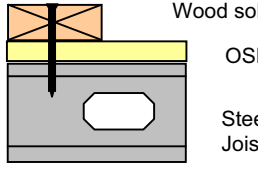
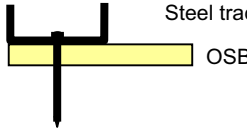
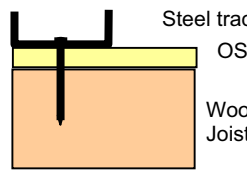
CONFIGURATION	NO STEEL	33 MIL (JOIST OR TRACK)	54 MIL (JOIST OR TRACK)
 <p>Wood OSB</p>	<p>Nail: 0.131" x 3.25" (pneumatic) (1)</p> <p>Screws: #8 x 3" self-tapping, flat head (2) #10 x 3" self-tapping, flat head (3)</p>		
 <p>Wood sole OSB Steel Joist</p>		<p>Nail: 0.131" x 3.25" (pneumatic) (1)</p> <p>Screws: #8 x 3" self-drilling, bugle head (5)</p>	<p>Nail: 0.131" x 3.25" (pneumatic) (1)</p> <p>Screws: #8 x 3" self-drilling, bugle head (5)</p>
 <p>Steel track OSB</p>		<p>Nail: 0.131" x 3.25" (pneumatic) (1)</p> <p>Screws: #8 x 1.5" self-piercing, wafer head (fully threaded) (6)</p>	<p>Nail: 0.131" x 3.25" (pneumatic) (1)</p> <p>Screws: #8 x 1-5/8" self drilling, wafer head (fully threaded) (7)</p>
 <p>Steel track OSB Wood Joist</p>		<p>Nail: 0.131" x 3.25" (pneumatic) (1)</p> <p>Screws: #8 x 3" self-piercing, wafer head (partially threaded) (4)</p>	<p>Nail: 0.131" x 3.25" (pneumatic) (1)</p> <p>Screws: #10 x 2.5" self-drilling, pan head (fully threaded) (8)</p>

Note: Numbers in parenthesis (X) represent the fastener reference number as shown in Figure 3.

Experimental Approach

A series of tests were conducted to examine two types of hybrid, wall-to-floor connections: (1) steel-to-wood and (2) wood-to-steel. The objective was to determine the lateral shear and uplift capacity for each type of connection. Various fasteners were used in each test plan. Tests were made with the fastener driven through the sole plate, sheathing, and into the joist, or with the fastener driven through the sole plate and sheathing only. Each connection was tested in shear and withdrawal. Load verses displacement relationships were plotted for each test and failure modes were noted. A total of twenty-six different test sets were conducted. Each set consisted of the AISI [3][4] minimum of four tests per connection.

Wood Framed Wall to CFS Floor

SHEAR TEST SPECIMENS

The specimens for the shear tests were designed to simulate the connection of a wood wall to a CFS floor system sheathed with OSB. Each specimen consisted of a light gauge steel framed panel. The floor joists were attached to rim track at 8-inches on center with #8 x 1/2" wafer head screws. A 54 mil (16 gauge) and a 33 mil (20 gauge) version of the frame was tested. The frames were sheathed on each face to accommodate the maximum number of tests per frame. The sheathing was 23/32-inch-thick OSB and was attached to the frame with #8 x 1-5/8" bugle head, self-drilling, reamer-tipped screws spaced 6" on center on the edges and 12-inches on center in the field. Twelve-inch long sole plates were attached to the frame using one fastener per sole plate. The sole plate material was 2x4-inch nominal Spruce Pine Fir (SPF) Stud-grade and had a moisture content below 19 percent at the time of fabrication and testing. The sole plate blocks were attached to the frame leaving two inches overhanging the side to accommodate displacement during the tests (Figure 4). A series of tests were done with the sole plate fastener penetrating into the steel joist, and a series was done with the sole plate fastener penetrating into the OSB sheathing only (missing the joist). A total of 28 sole plate specimens were attached to each frame (14 on the top side, and 14 on the bottom side), and each sole plate was tested individually.

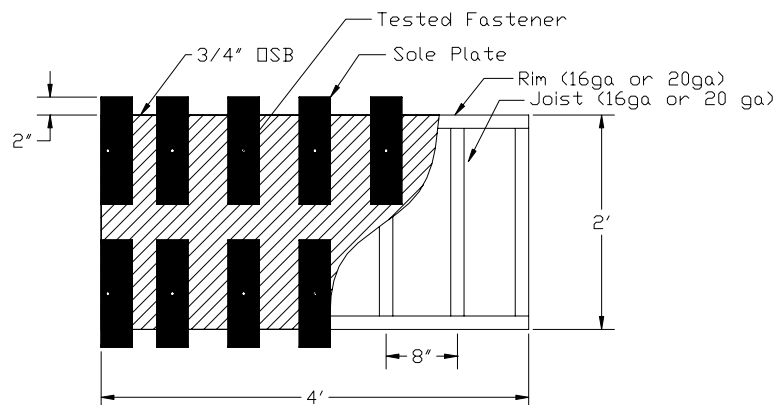

FIGURE 4
SHEAR TEST SPECIMEN FOR WOOD-TO-STEEL CONNECTIONS

SHEAR TESTING APPARATUS

The shear specimens were tested with a 200,000 lb capacity universal test machine (UTM, Southwark-Emery Model 78075), a Satec, Epsilon Series, 4-inch displacement gauge, and a Newvision II Data Acquisition System. The specimens were mounted on the UTM such that the stationary crosshead applied compression load on the protruding SPF sole plate at a constant displacement rate of 0.10 inches per minute. This follows the displacement rate used in ASTM D 1761[7] for lateral shear testing of fasteners in wood. The bottom of the frame was securely attached to the UTM table with bar clamps. The sole plate specimens were oriented in a parallel to grain loading direction. A 1000 lb capacity load cell was mounted between the cross head and the plate to measure the compression load. A 4-inch displacement gauge was mounted on the sheathing to measure relative movement between the sole plate and the sheathing (see Figure 5).

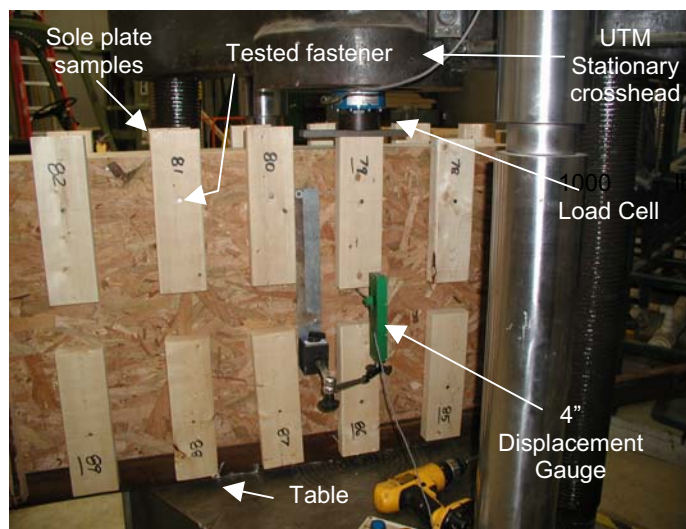

FIGURE 5
SHEAR TEST SPECIMEN IN UTM

WITHDRAWAL TEST SPECIMENS

The specimens for the withdrawal tests were “T” sections formed from 6-inch wide strips of 23/32-inch-thick OSB attached to light gauge steel joists. Specimens were also made without the steel joist (Figure 6). The specimens were 48 inches long and were fastened together with #8 x 1-5/8” bugle head, self-drilling, reamer-tipped screws spaced 6-inches on center. The test fasteners were driven through a sacrificial sole plate and into the specimen. Prior to testing, the sole plate was removed without disturbing the fastener, which was left protruding 1.5 inches out of the specimen. Test fasteners were installed at three inches on center along the “T” section to allow multiple tests per specimen.

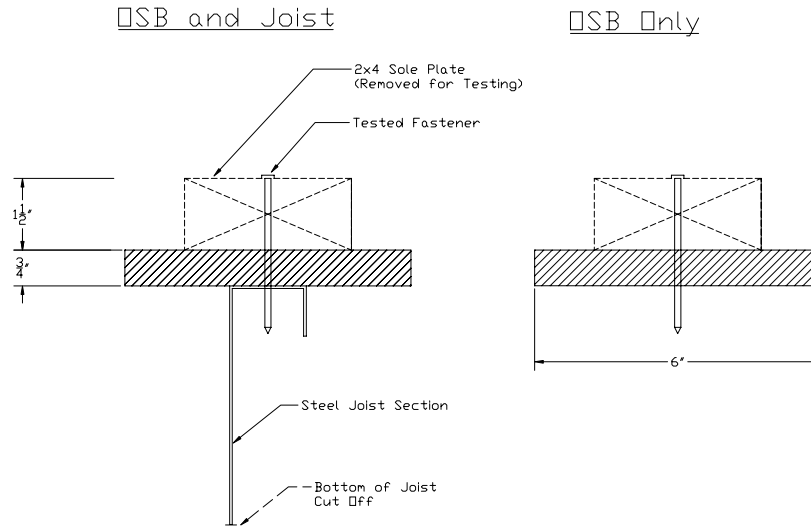

FIGURE 6
WITHDRAWAL TEST SPECIMENS FOR WOOD-TO-STEEL CONNECTIONS

WITHDRAWAL TESTING APPARATUS

The withdrawal specimens were mounted in a “C” shaped support attached to the one head of the UTM. Tension load was applied at a constant displacement rate of 0.10 inches per minute. The opposite head of the UTM was equipped with a nail claw, which was allowed to rotate about one axis and securely grip the fastener head. A 1000 lb capacity load cell was mounted on the underside of the upper crosshead to measure the withdrawal load. A Satec, Epsilon-series, 1-inch displacement gauge was mounted on the stationary head to measure withdrawal movement of the nail relative to the surface of the adjacent OSB sheathing (see Figure 7).

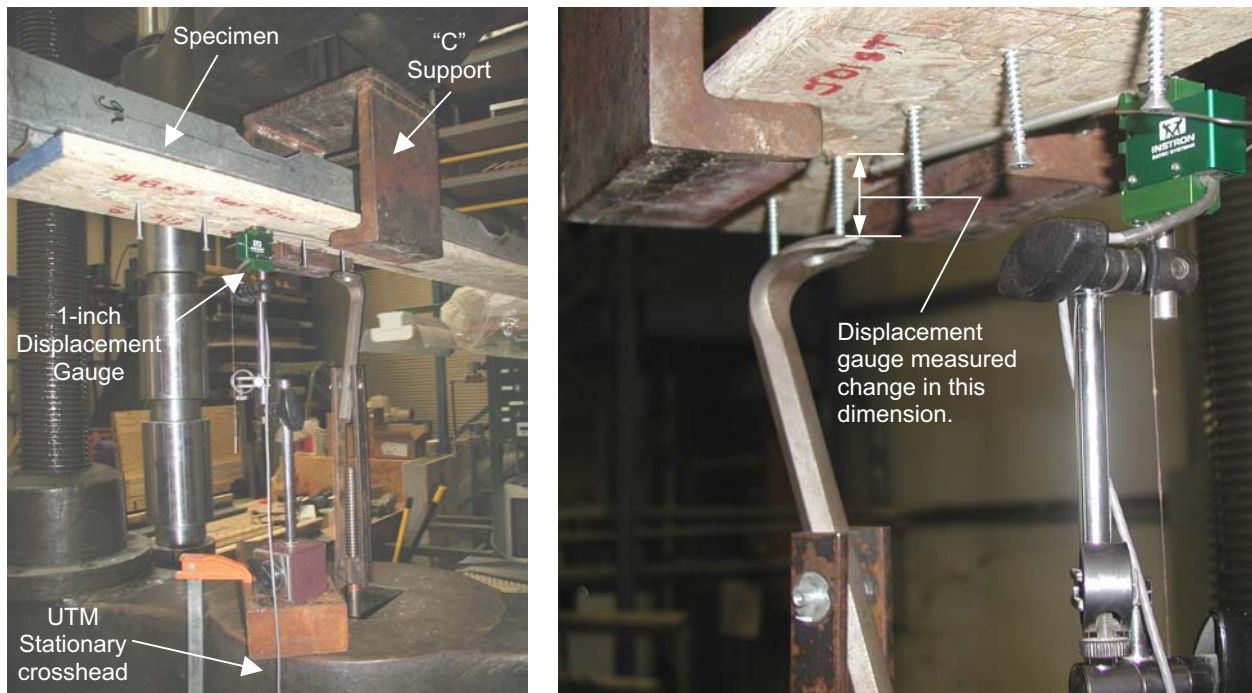

FIGURE 7
WITHDRAWAL TEST SPECIMEN IN THE UTM

TEST MATRIX

Seven shear and seven withdrawal test sets were completed. Each set had a variation in the fastener type and substrate, and consisted of a minimum of four tests. A total of 28 individual shear tests and 50 individual withdrawal tests were done. The matrix in Table 2 shows the fasteners, materials, and number of tests conducted for each set.

**TABLE 2
WOOD-TO-STEEL TEST MATRIX**

FASTENER	Ref. Number	NUMBER OF REPETITIONS					
		Shear			Withdrawal		
		OSB only	OSB and 20 ga	OSB and 16 ga	OSB only	OSB and 20 ga	OSB and 16 ga
0.131-inch x 3 1/4-inch pneumatic nail	1	4	4	6	10	5	5
#8 x 3-in self-tapping, flat head screw	2	4			10		
#10 x 3-in self-tapping, flat head screw	3	4			10		
#8 x 3-in self-drilling, bugle head screw	5		4	4		5	5

RESULTS

Table 3 is a summary of the wood wall to steel floor test results. For individual test results see Appendix A.

**TABLE 3
WOOD-TO-STEEL TEST RESULTS SUMMARY**

SHEAR TEST RESULTS							
Test Set	Fastener	Ref #	Substrate	# Tests	Avg. Ult.	Std. Dev.	COV
1	0.131" x 3.25" Nail	1	OSB	4	332.1 lbs	73.8 lbs	0.22
2	# 8 x 3" Screw (ST, FH)	2	OSB	4	413.0 lbs	43.6 lbs	0.11
3	#10 x 3" Screw (ST, FH)	3	OSB	4	623.1 lbs	84.1 lbs	0.13
4	0.131" x 3.25" Nail	1	OSB – 20ga	4	387.6 lbs	25.7 lbs	0.07
5	# 8 x 3" Screw (SD, BH)	5	OSB – 20ga	4	385.1 lbs	87.9 lbs	0.23
6	0.131" x 3.25" Nail	1	OSB – 16ga	6	454.8 lbs	62.5 lbs	0.14
7	# 8 x 3" Screw (SD, BH)	5	OSB – 16ga	4	459.7 lbs	48.0 lbs	0.10
WITHDRAWAL TEST RESULTS							
Test Set	Fastener	Ref #	Substrate	# Tests	Avg. Ult.	Std. Dev.	COV
8	0.131" x 3.25" Nail	1	OSB	10	119.2 lbs	43.5 lbs	0.36
9	# 8 x 3" Screw (ST, FH)	2	OSB	10	296.6 lbs	65.8 lbs	0.22
10	#10 x 3" Screw (ST, FH)	3	OSB	10	304.6 lbs	60.8 lbs	0.20
11	0.131" x 3.25" Nail	1	OSB – 20ga	5	211.0 lbs	18.7 lbs	0.09
12	# 8 x 3" Screw (SD, BH)	5	OSB – 20ga	5	527.8 lbs	74.6 lbs	0.14
13	0.131" x 3.25" Nail	1	OSB – 16ga	5	323.8 lbs	36.9 lbs	0.11
14	# 8 x 3" Screw (SD, BH)	5	OSB – 16ga	5	1031.8 lbs	65.7 lbs	0.06

ST = Self-tapping, SD = Self-drilling, FH = Flat head, BH = Bugle head
For SI : 1 inch = 25.4 mm, 1 lb = 4.448 N

FAILURE MODES

Different failure modes were observed in the various shear test sets, but were consistent within each set. The nailed connections exhibited nail yielding at ultimate load, but continued to support near-ultimate loads through large sole plate displacements. The screwed connections exhibited a less ductile failure, with loads dropping off abruptly after the ultimate load was achieved. The ultimate load corresponded with the breakage of the screw (see Figure 8).

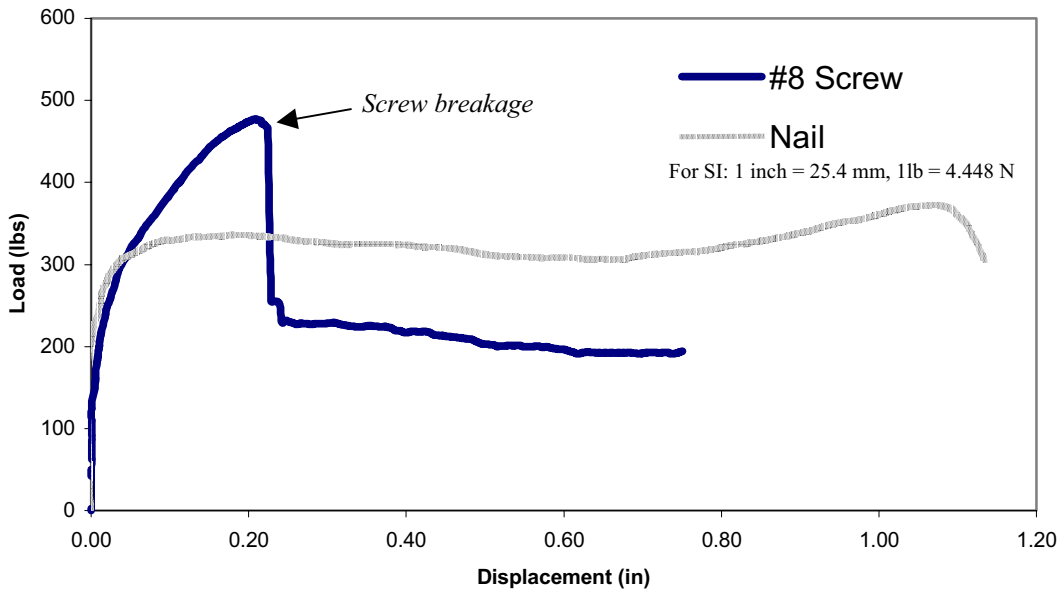

FIGURE 8
TYPICAL SHAPES OF SHEAR TEST CURVES

The mode of failure for all withdrawal tests was fastener pullout. Fastener yielding or failure was not observed. The load versus displacement curves had consistent patterns within test sets. The screwed connections typically reached an ultimate capacity, and then began to pull out of the substrate. As the screw pulled out, the threads became less effective and the resistance reduced. The nailed connections generally reached an ultimate capacity, and then began to pull out with a fairly constant resistance, which was slightly below the ultimate level (see Figure 9). These load-displacement patterns were consistent for all withdrawal tests. Note the load delay in the nail curve. This was likely caused by the gradual engagement of the claw grip on the nail head.

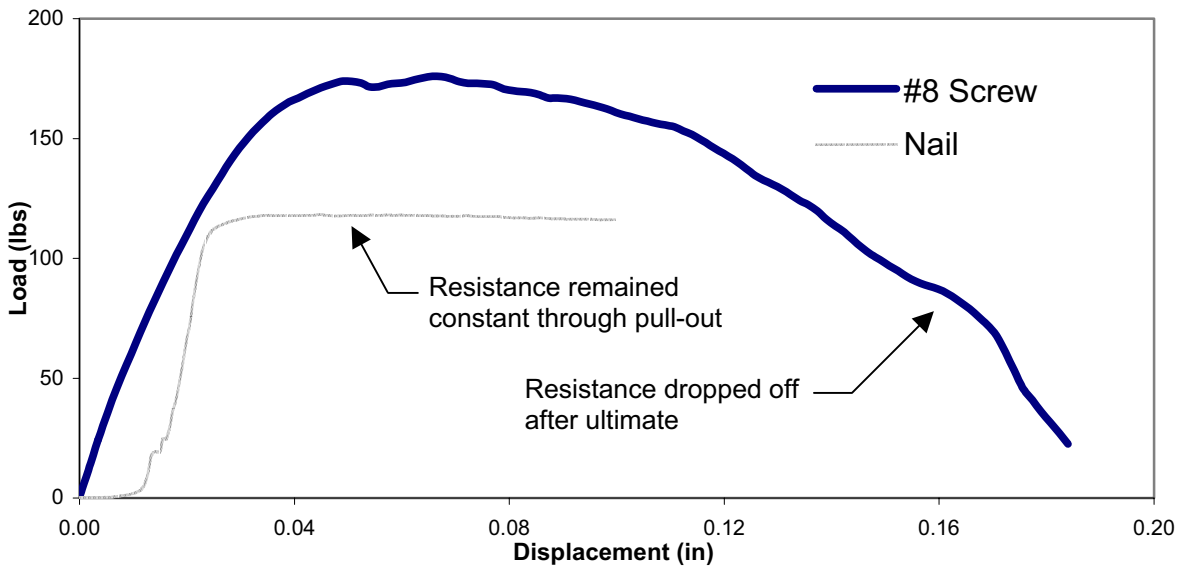

FIGURE 9
TYPICAL SHAPES OF WITHDRAWAL TEST CURVES

CFS Wall to Wood Frame Floor

SHEAR TEST SPECIMENS

The specimens for the steel-to-wood shear tests were similar to the wood-to-steel test specimens. Wood frames, matching the dimensions shown in Figure 4, were constructed using 2x6 SPF joists. The frames were sheathed on each face with 23/32-inch-thick OSB, which was attached with 8d common nails at 6 inches on center on the perimeter and 12 inches on center in the field. Thirty-inch long wall track sections (33 mil and 54 mil) were attached to the frames similar to how they were in the wood sole plate tests. Each steel track sole plate had a stiffener section fastened to it to provide a bearing surface for the UTM, and to prevent buckling of the track (see Figure 10). The stiffeners were attached with four #8 screws (two on each side of the track, spaced 24 inches apart).

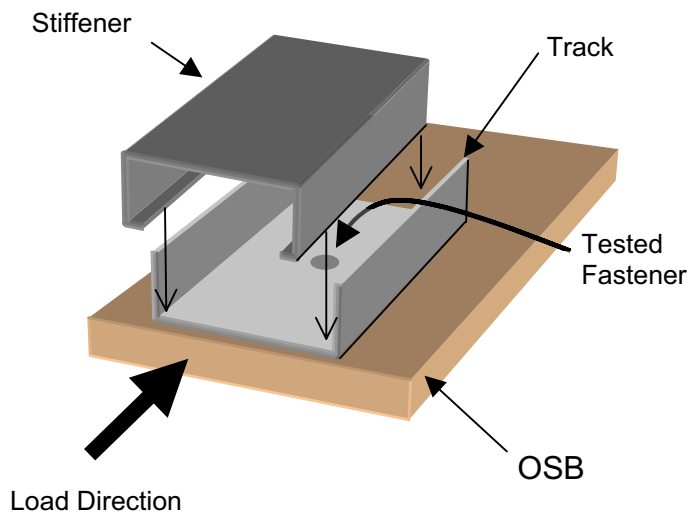
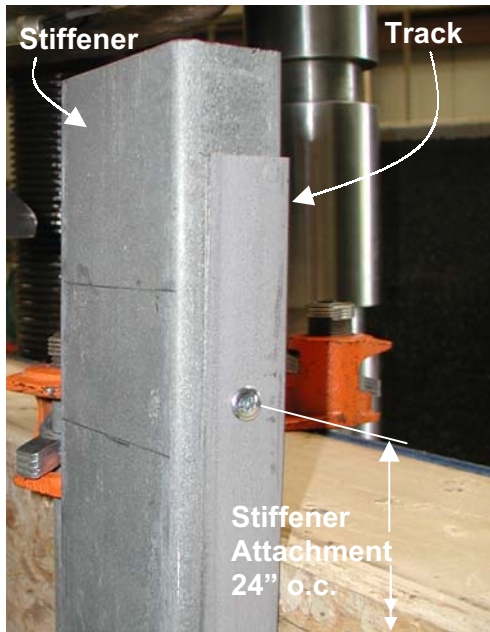

FIGURE 10
SHEAR TEST SPECIMEN

SHEAR TESTING APPARATUS

The shear testing apparatus for the steel-to-wood study was the same as the apparatus used for the wood-to-steel study. The frames were positioned on the UTM so that the crosshead applied compression load on the protruding stiffener. The load was applied using a constant displacement rate of 0.10 inches per minute. A 1000 lb capacity load cell was mounted between the cross head and the stiffener to measure the compression load, and a 4-inch displacement gauge was mounted directly on the sheathing to measure relative movement between the sole plate and the sheathing (see Figure 11).

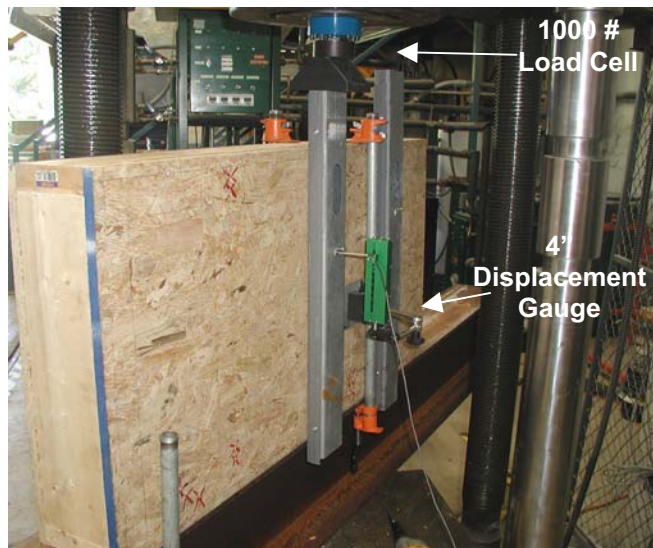

FIGURE 11
SHEAR TEST SPECIMEN IN UTM

WITHDRAWAL TEST SPECIMENS

One of the possible uplift failure modes for a steel wall to wood floor connection is fastener head pull-through. Therefore, withdrawal tests for the steel-to-wood connections were done by applying the loads to the flanges of the attached steel track, instead of to the fastener head as was done in the wood-to-steel tests. This allowed for a possible head pull-through failure. The specimens consisted of 3-inch pieces of wall track (33 mil and 54 mil) attached to wood “T”-sections. A 40-mil stud was attached to the track directly over the tested fastener and provided connection to the UTM. Four #8 x 5/8” wafer head screws were used to attach the stud to the track (two on each side). The “T”-sections consisted of 2x4 SPF joist sections sheathed with 23/32-inch OSB (see Figure 12).

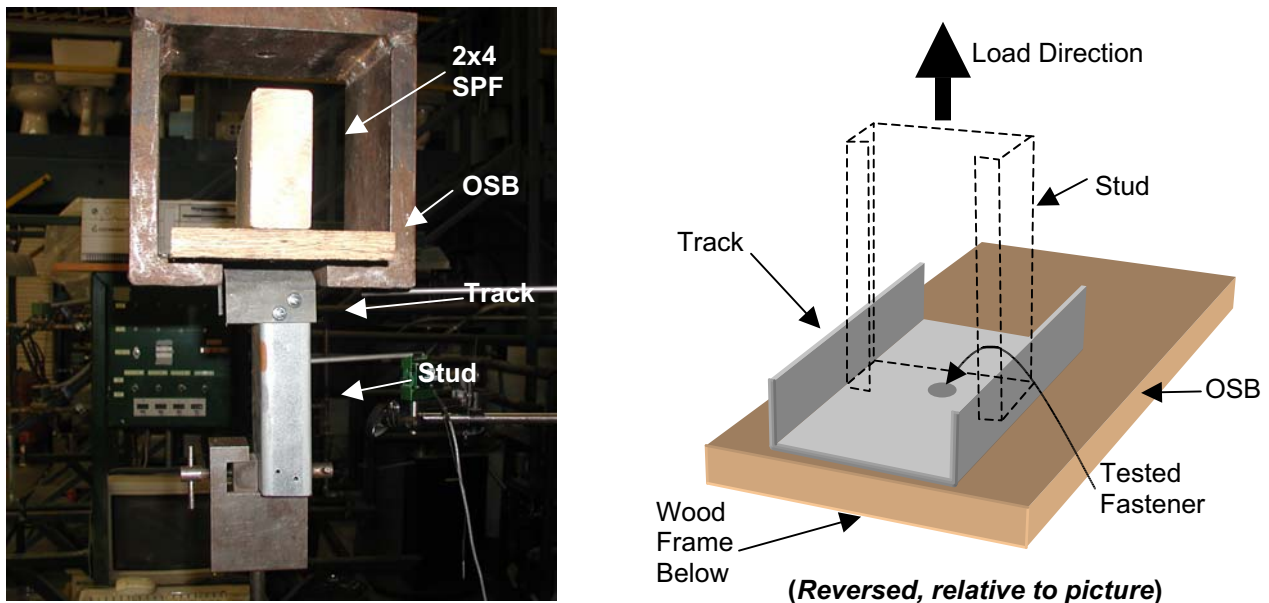

FIGURE 12
WITHDRAWAL TEST SPECIMEN

WITHDRAWAL TESTING APPARATUS

The withdrawal specimens were mounted in a “C”-shaped support attached to the moving head of the UTM (see Figure 13). Load was applied at a displacement rate of 0.10 inches per minute. The stationary head of the UTM was equipped with a clamping grip, which provided connection to the stud. A 1000 lb capacity load cell was mounted on the underside of the stationary crosshead to measure the withdrawal load. Two 1-inch displacement gauges were mounted on the stationary head. One measured total displacement between the frame and the stud, and the other measured withdrawal of the fastener from the frame (see Figure 14).

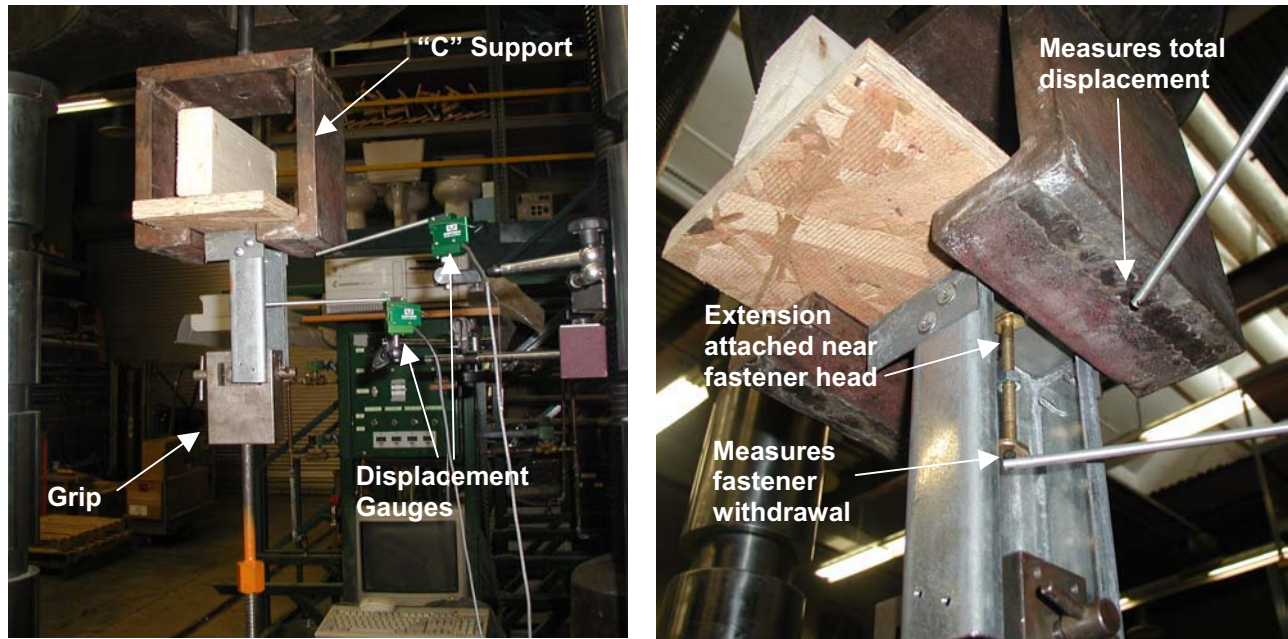

FIGURE 13
WITHDRAWAL TEST SPECIMEN IN UTM

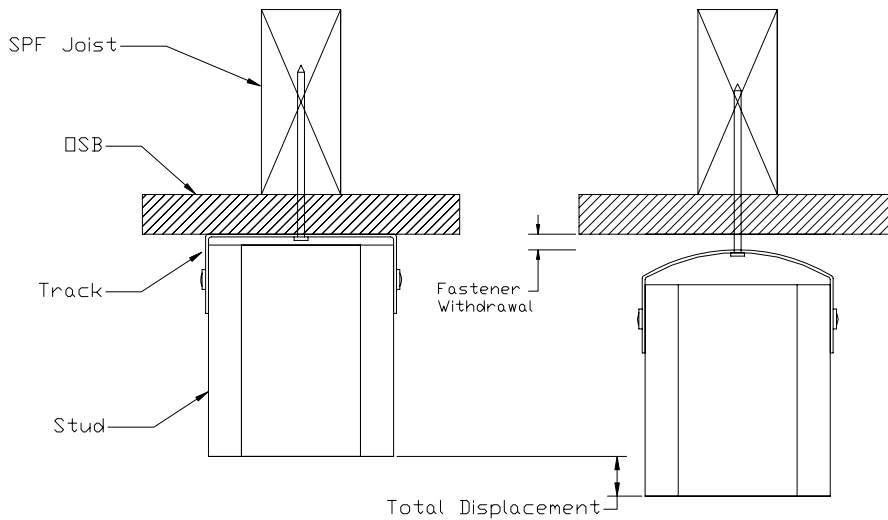

FIGURE 14
DISPLACEMENTS MEASURED IN WITHDRAWAL TESTS

TEST MATRIX

Six shear, and six withdrawal test sets were completed. Each set had a variation in the fastener type and substrate. A total of 31 shear tests and 33 withdrawal tests were conducted. The matrix in Table 4 shows the fasteners, materials, and minimum numbers of tests run for each set. There was a minimum of 4 tests per set. Following AISI[3][4], additional tests were conducted (up to 6 per set) if any one test varied 15 percent from the average test value for that set.

**TABLE 4
STEEL TO WOOD TEST MATRIX**

TRACK	FASTENER	REF. NUMBER	NUMBER OF REPETITIONS			
			Shear		Withdrawal	
			OSB only	OSB and SPF Joist	OSB only	OSB and SPF Joist
33 mil	0.131-inch x 3 1/4-inch pneumatic nail	1	6	5	6	6
	#8 x 1.5", self-piercing, wafer hd (fully threaded)	6	5		6	
	#8 x 3" self-piercing, wafer hd. (part. threaded)	4		4		7
54 mil	0.131-inch x 3 1/4-inch pneumatic nail	1				
	#8 x 1-5/8" self-drill., wafer hd. (fully threaded)	7	4		4	
	#10 x 2.5" self-drill., pan head (fully threaded)	8		6		4

RESULTS

Table 5 is a summary of the steel wall to wood floor test results. For individual test results see Appendix A.

**TABLE 5
STEEL-TO-WOOD TEST RESULTS SUMMARY**

SHEAR TEST RESULTS							
TEST SET	FASTENER	REF #	SUBSTRATE	# TESTS	AVG. ULT.	STD. DEV.	COV
15	0.131"x 3.25" Nail	1	OSB	6	268.5 lbs	37.1 lbs	0.138
16	# 8 x 1.5" Screw (SP, WH)	6	OSB	5	412.2 lbs	88.8 lbs	0.215
17	# 8 x 1-5/8" Screw (SD, WH)	7	OSB	4	542.6 lbs	24.3 lbs	0.045
18	0.131"x 3.25" Nail	1	OSB-SPF	5	667.0 lbs	68.8 lbs	0.103
19	# 8 x 3" Screw (SP, WH)	4	OSB-SPF	4	620.0 lbs	80.3 lbs	0.129
20	#10 x 2.5" Screw (SD, PH)	8	OSB-SPF	6	1402.1 lbs	178.7 lbs	0.127
WITHDRAWAL TEST RESULTS							
21	0.131"x 3.25" Nail	1	OSB	6	74.9 lbs	23.4 lbs	0.312
22	# 8 x 1.5" Screw (SP, WH)	6	OSB	6	350.2 lbs	71.6 lbs	0.204
23	# 8 x 1-5/8" Screw (SD, WH)	7	OSB	4	331.0 lbs	35.0 lbs	0.106
24	0.131"x 3.25" Nail	1	OSB-SPF	6	402.0 lbs	48.8 lbs	0.121
25	# 8 x 3" Screw (SP, WH)	4	OSB-SPF	7	*630.5 lbs	127.2 lbs	0.202
26	#10 x 2.5" Screw (SD, PH)	8	OSB-SPF	4	1007.5 lbs	87.8 lbs	0.087

SP = Self-piercing, SD = Self drilling, WH = Wafer head, PH = Pan head

*Value is for a (2) fastener connection

For SI: 1 inch = 25.4 mm, 1lb = 4.448N

FAILURE MODES

The failure modes varied among fastener types. The nailed connections exhibited ductile failures by sustaining near ultimate loads through large displacements. Beyond the ultimate load, the nails typically deformed, creating a plastic hinge within the sheathing, which is characteristic to Mode-IIIs yielding as defined in the NDS[1]. After the nail yielded, it began to withdraw from

the substrate. In contrast, the screwed connections broke in an abrupt manner. The break was consistently near the head of the screw at the steel-wood interface.

The withdrawal failure modes varied by fastener and substrate type. In tests where the fastener was driven into the sheathing only, fastener pullout was observed at relatively low load levels. When the fastener was driven into the sheathing and joist, either the head of the fastener broke off, or large bending deformations in the track and stud occurred before the fastener pulled out of the substrate. Tests, which exhibited large specimen deformation prior to fastener withdrawal or failure were repeated using two fasteners (one on each edge of the track.) or with one fastener toward the edge of the track and the grip shifted to align the load (see Figure 15). This prevented the excessive track deformation prior to the connection failure. These tests ended with the fastener head breaking off.



FIGURE 15
FASTENER LOCATIONS FOR STEEL-TO-WOOD WITHDRAWAL TESTS

Discussion

Lateral restraint of the sole plate was inherent in all shear tests. The top of the sole plate specimen was secured to the load head by static friction, and prevented the sole plate from shifting away from the frame as load was applied (see Figure 16). A test, which allowed for lateral freedom of the sole plate, was performed to compare the resistance effects between an unrestrained specimen and a restrained specimen. Rollers were placed between the load cell and the bearing plate to allow movement in the direction of fastener withdrawal. The unrestrained specimens in these tests reached ultimate load and then dropped resistance quickly as the sole plate pulled away from the frame due to eccentric loading. The restrained specimen typically maintained near ultimate resistance through large displacements. The ultimate loads were similar in the restrained and unrestrained tests, but total displacements before failure varied significantly (see Figure 17).

The restrained test method was used to determine fastener capacity in this study. In a building assembly, the wall dead load and uplift hardware will prevent the sole plate from shifting away from the frame, thus the connection is more accurately modeled by the restrained test method.

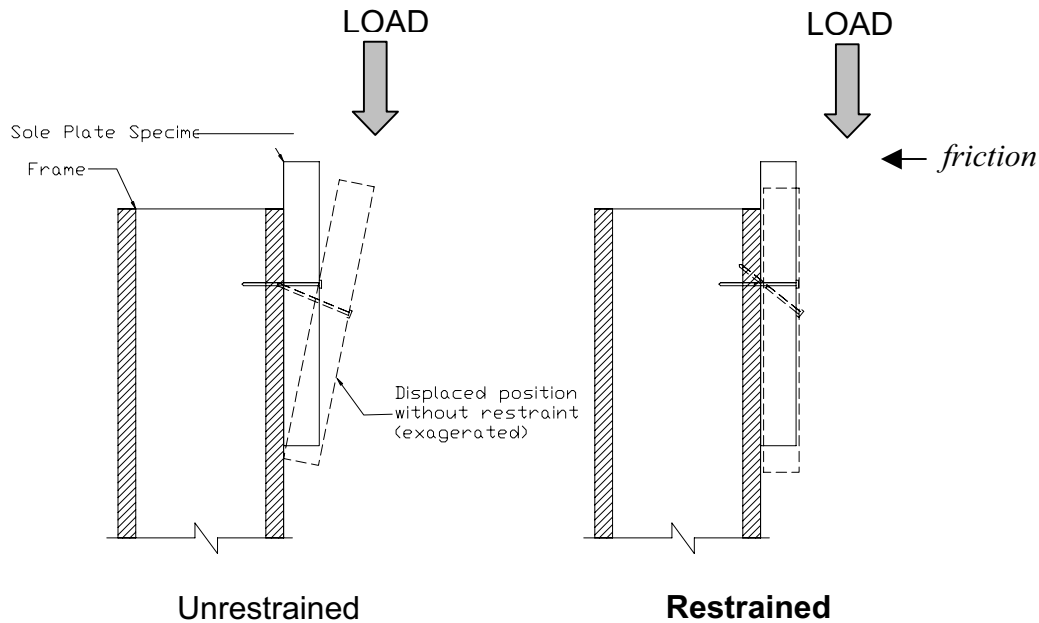

FIGURE 16
EFFECT OF LATERAL RESTRAINT ON SHEAR TESTS

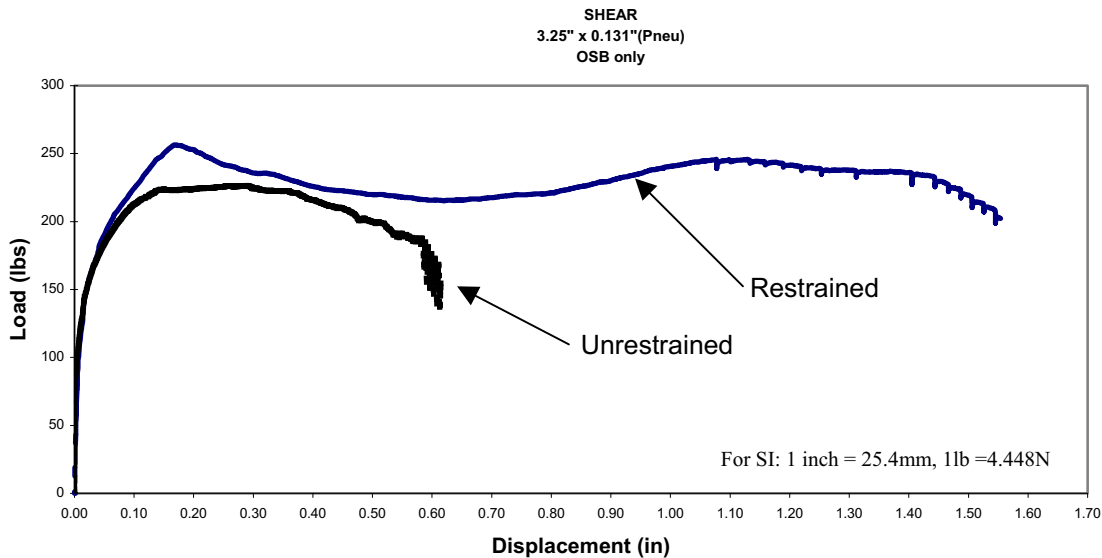

FIGURE 17
LATERALLY RESTRAINED AND UNRESTRAINED TEST RESULTS

Recommendations

Tables 6 and 7 show recommended fastener schedules for hybrid, wall-to-floor connections. These connection schedules are based on transverse (perpendicular to the face of the wall) wind loads only, and are applicable to walls up to 10 feet in height, for structures with an A or B exposure defined by ASCE-7 [5]. The nominal shear resistance, based on the schedule, is also

provided. The fastener schedules, and corresponding resistances have not been increased for load duration and should not be adjusted for duration of load in design since the substrate is a combination of wood and steel. Adjustments for moisture content and lumber density could be applied, but only to lower the nominal values, since the resistance contribution of the wood (SPF) in the substrate is unknown. For varying lumber species, nominal values should be adjusted in proportion to the lumber densities. For example, SPF (South), (S.G. = 0.36) would require an adjustment factor of $0.36 / 0.42 = 0.86$, but Southern Pine would not require an adjustment since the density (S.G. = 0.55) is higher than that of SPF (S.G. = 0.42). Adjustments for lumber moisture content should be made using NDS [1] Wet Service Factors (C_m).

**TABLE 6
FASTENER SCHEDULE FOR WOOD-TO-STEEL CONNECTION**

WOOD WALL TO STEEL FLOOR				Up to 110 mph (3 Sec Gust), Exp A/B; Max wall hgt. = 10'	SHEAR RESISTANCE PROVIDED	Up to 140 mph (3 Sec Gust), Exp A/B; Max wall hgt. = 10'	SHEAR RESISTANCE PROVIDED
Substrate	Fastener	Nominal Shear	Nominal Withdr.	Spacing ₅		Spacing ₅	
OSB only	10D Nail ₁	92 lbs	24 lbs	(2) / 16"	138 plf	(3) / 16"	207 plf
	#8 Screw ₂	115 lbs	59 lbs	(2) / 16"	172 plf	(2) / 16"	172 plf
	#10 Screw ₃	173 lbs	61 lbs	(1) / 16"	129 plf	(2) / 16"	259 plf
20 Gauge Floor	10D Nail ₁	107 lbs	42 lbs	(2) / 16"	160 plf	(2) / 16"	160 plf
	#8 Screw ₄	107 lbs	106 lbs	(2) / 16"	160 plf	(2) / 16"	160 plf
16 Gauge Floor	10D Nail ₁	126 lbs	65 lbs	(2) / 16"	189 plf	(2) / 16"	189 plf
	#8 Screw ₄	128 lbs	206 lbs	(2) / 16"	192 plf	(2) / 16"	192 plf

Fastener Specifications:

- 0.131" x 3.25" pneumatic nail
- #8 x 3" self tapping, flat head
- #10 x 3" self tapping, flat head
- #8 x 3" self drilling, bugle head

5. (2) / 16" = (2) fasteners equally spaced every 16 inches

Note: Fastener schedules are based on requirements for transverse (perpendicular to face of wall) wind loads only. Connection requirements for uplift and shear must be verified. Requirements based on SPF lumber, MC = 19% or less.

For SI: 1 inch = 25.4mm, 1lb = 4.448N, 1plf = 1.488 kg/m

**TABLE 7
FASTENER SCHEDULE FOR STEEL-TO-WOOD CONNECTION**

STEEL WALL TO WOOD FLOOR					Up to 110 mph (3 Sec Gust), Exp A/B; Max wall hgt. = 10'	SHEAR RESISTANCE PROVIDED	Up to 140 mph (3 Sec Gust)ExpA/B; Max wall hgt. = 10'	SHEAR RESISTANCE PROVIDED
Track	Substrate	Fastener	Nominal Shear	Nominal Withdr.	Spacing ₆		Spacing ₆	
20 ga	OSB	10D Nail ₁	74 lbs	15 lbs	(3) / 24"	111 plf	(5) / 24"	185 plf
		#8 Screw ₂	137 lbs	70 lbs	(2) / 24"	137 plf	(3) / 24"	205 plf
	OSB – 2x6 SPF	10D Nail ₁	185 lbs	80 lbs	(2) / 24"	185 plf	(2) / 24"	185 plf
		#8 Screw ₃	172 lbs	63 lbs	(2) / 24"	172 plf	(2) / 24"	172 plf
16 ga	OSB	#8 Screw ₄	151 lbs	66 lbs	(2) / 24"	151 plf	(3) / 24"	226 plf
	OSB – 2x6 SPF	#10 Screw ₅	389 lbs	202 lbs	(1) / 24"	194 plf	(2) / 24"	389 plf

Fastener Specifications:

- 0.131" x 3.25" pneumatic nail
- #8 x 1.5" self piercing, wafer head (fully threaded)
- #8 x 3" self piercing, wafer head (partially threaded)
- #8 x 1-5/8" self drilling, wafer head (fully threaded)
- #10 x 2.5" self drilling, pan head (fully threaded)

6. (2) / 24" = (2) fasteners every 24 inches

Note: Fastener schedules are based on requirements for transverse (perpendicular to face of wall) wind loads only. Connection requirements for uplift and shear must be verified. Requirements based on SPF lumber, MC = 19% or less.

For SI: 1 inch = 25.4mm, 1lb = 4.448N, 1plf = 1.488 kg/m

Conclusion

The fastening schedules presented in this report provide practical solutions for hybrid, wall-to-floor connections. The fasteners were chosen to accommodate specific building materials readily available in the home building market. High cost, specialty fasteners were avoided. Substitute fasteners, with equal or higher design values, can be used, but proper fastener characteristics, such as head type, point style, and threading, must be suitable for the intended use.

The fastening schedules recommended in this report are for resistance to transverse (perpendicular to the face of the wall) wind loads only. These schedules should not be relied upon for shear and uplift resistance that may be required for whole-building lateral design, unless they are specifically checked using the allowable capacities provided.

Some of the tests done in this study involved fastening the sole plate to the OSB sheathing only. The purpose of this was to investigate the effectiveness of this connection and determine if it would be an acceptable fastening option. If so, it would allow framers to quickly and easily install walls without having to be concerned with accurate fastener placement. It would also allow inspectors to easily verify proper attachment by counting fastener heads on the sole plate.

The connection schedules for the OSB-only and the OSB-joist are similar. Generally, only one or two additional fasteners are required per sixteen or twenty-four inches when fasteners are installed into the OSB only. Therefore, the sole plate to sheathing only connection is a viable, efficient, and economical connection option. Uplift values are lower in the OSB-only connections, but this could be addressed with additional fasteners or separate hold-downs if required. Adding additional fasteners to allow for this type of connection is a cost effective alternative, since the speed of wall installation could be increased without compromising the needed capacity.

References

- [1] *National Design Specification for Wood Construction (NDS)*, 1997 Edition, American Forest and Paper Association, American Wood Council, Washington, DC, June 1997.
- [2] *National Design Specification for Wood Construction Commentary*, 1997 Edition, American Forest and Paper Association, American Wood Council, Washington, DC, June 1997.
- [3] *North American Specification for the Design of Cold-Formed Steel Structural Members*, 2001 Edition, American Iron and Steel Institute (AISI), Washington, DC, June 2002.
- [4] *Commentary on North American Specification for the Design of Cold-Formed Steel Structural Members*, 2001 Edition, American Iron and Steel Institute (AISI), Washington, DC, June 2002.
- [5] *Structural Design Loads for One- and Two- Family Dwellings*, U.S. Department of Housing and Urban Development, Office of Policy Development and Research, Washington, DC, May 2001.
- [6] *Minimum Design Loads for Buildings and Other Structures (ASCE 7-98)*, American Society of Civil Engineers, Reston, VA, January 2000.
- [7] ASTM D1761- 88 (Reapproved 1995) *Standard Test Methods for Mechanical Fasteners in Wood*, American Society for Testing and Materials (ASTM), West Conshohocken, PA. 1995.

Appendix A

MASTER TEST SET LIST

WOOD-TO-STEEL					
Test Set	Test Type	Sole Plate	Substrate	Fastener	Ref #
1	Shear	2x4 SPF	OSB only	0.131" x 3.25" pneumatic nail - bright	1
2	Shear	2x4 SPF	OSB only	#8 x 3" self-tapping, flat head, screw	2
3	Shear	2x4 SPF	OSB only	#10 x 3" self-tapping, flat head, screw	3
4	Shear	2x4 SPF	OSB-33 mil	0.131" x 3.25" pneumatic nail - bright	1
5	Shear	2x4 SPF	OSB-33 mil	#8 x 3" self-drilling, bugle head, screw	5
6	Shear	2x4 SPF	OSB-54 mil	0.131" x 3.25" pneumatic nail - bright	1
7	Shear	2x4 SPF	OSB-54 mil	#8 x 3" self-drilling, bugle head, screw	5
8	Withdrawal	2x4 SPF	OSB only	0.131" x 3.25" pneumatic nail - bright	1
9	Withdrawal	2x4 SPF	OSB only	#8 x 3" self-tapping, flat head, screw	2
10	Withdrawal	2x4 SPF	OSB only	#10 x 3" self-tapping, flat head, screw	3
11	Withdrawal	2x4 SPF	OSB-33 mil	0.131" x 3.25" pneumatic nail - bright	1
12	Withdrawal	2x4 SPF	OSB-33 mil	#8 x 3" self-drilling, bugle head, screw	5
13	Withdrawal	2x4 SPF	OSB-54 mil	0.131" x 3.25" pneumatic nail - bright	1
14	Withdrawal	2x4 SPF	OSB-54 mil	#8 x 3" self-drilling, bugle head, screw	5
STEEL-TO-WOOD					
Test Set	Test Type	Sole Plate	Substrate	Fastener	Ref #
15	Shear	33 mil	OSB only	0.131" x 3.25" pneumatic nail - bright	1
16	Shear	33 mil	OSB only	#8 x 1.5" self-piercing, wafer head, screw	6
17	Shear	54 mil	OSB only	#8 x 1-5/8" self-drilling, wafer head, screw	7
18	Shear	33 mil	OSB-SPF	0.131" x 3.25" pneumatic nail - bright	1
19	Shear	33 mil	OSB-SPF	#8 x 3" self-piercing, wafer head, screw	4
20	Shear	54 mil	OSB-SPF	#10 x 2.5" self-drilling, pan head, screw	8
21	Withdrawal	33 mil	OSB only	0.131" x 3.25" pneumatic nail - bright	1
22	Withdrawal	33 mil	OSB only	#8 x 1.5" self-piercing, wafer head, screw	6
23	Withdrawal	54 mil	OSB only	#8 x 1-5/8" self-drilling, wafer head, screw	7
24	Withdrawal	33 mil	OSB-SPF	0.131" x 3.25" pneumatic nail - bright	1
25	Withdrawal	33 mil	OSB-SPF	#8 x 3" self-piercing, wafer head, screw (*)	4
26	Withdrawal	54 mil	OSB-SPF	#10 x 2.5" self-drilling, pan head, screw	8
*Test set #25 used (2) fasteners for testing.					

Hybrid Wood and Steel, Sole Plate Connection – Walls to Floors Testing Report

INDIVIDUAL TEST RESULTS

ULTIMATE LOAD (LBS) / DISPLACEMENT AT ULTIMATE LOAD (INCHES)

	1	2	3	4	5	6	7	8	9	10	Avg	Std. Dev	COV
1	420 1.639	363 0.981	292 0.091	254 1.109							332 0.955	74 0.643	0.222 0.673
2	464 0.350	385 0.456	369 0.385	434 0.494							413 0.421	44 0.066	0 0.156
3	602 0.612	747 0.429	573 0.404	570 0.502							623 0.486	84 0.093	0.135 0.192
4	372 1.070	407 1.203	359 1.045	411 0.972							388 1.073	26 0.096	0.066 0.090
5	305 0.126	478 0.210	315 0.131	443 0.379							385 0.211	88 0.118	0.228 0.558
6	355 1.119	529 1.199	479 1.285	460 1.477	495 1.356	411 0.854					455 1.215	62 0.216	0.137 0.178
7	518 0.267	468 0.155	401 0.098	452 0.206							460 0.181	48 0.072	0.104 0.396
8	118 0.104	137 0.118	99 0.134	185 0.194	180 0.133	70 0.191	97 0.174	55 0.189	102 0.113	150 0.123	119 0.147	43 0.036	0.365 0.243
9	295 0.047	314 0.069	409 0.063	303 0.049	364 0.063	312 0.054	300 0.058	218 0.067	275 0.051	176 0.057	297 0.058	66 0.008	0.222 0.133
10	234 0.040	187 0.038	340 0.550	297 0.054	296 0.061	381 0.063	367 0.068	294 0.094	290 0.078	361 0.105	305 0.115	61 0.154	0.200 1.341
11	221 0.118	193 0.086	222 0.094	230 0.101	189 0.089						211 0.098	19 0.012	0.089 0.127
12	530 0.220	621 0.205	577 0.191	440 0.174	470 0.210						528 0.200	75 0.018	0.141 0.090
13	333 0.619	354 0.690	272 0.385	300 0.744	359 0.736						324 0.635	37 0.148	0.114 0.233
14	1060 0.254	979 0.257	964 0.239	1029 0.239	1127 0.227						1032 0.243	66 0.013	0.064 0.052
15	229 0.071	220 0.136	297 0.210	313 0.100	277 0.079	276 0.128					269 0.120	37 0.051	0.138 0.420
16	542 0.138	426 0.194	406 0.240	393 0.384	294 0.250						412 0.241	89 0.091	0.215 0.379
17	553 0.119	534 0.116	569 0.101	513 0.118							543 0.113	24 0.009	0.045 0.076
18	707 0.158	547 0.114	682 0.125	685 0.286	715 0.179						667 0.172	69 0.068	0.103 0.396
19	673 0.024	582 0.027	699 0.043	526 0.030							620 0.031	80 0.008	0.129 0.267
20	1385 0.274	1333 0.300	1685 0.413	1318 0.308	1520 0.355	1171 0.156					1402 0.301	179 0.086	0.127 0.287
21	44 0.078	103 0.225	63 0.107	58 0.078	95 0.206	86 0.187					75 0.147	23 0.067	0.312 0.454
22	409 0.779	258 0.539	354 0.652	275 0.502	437 0.740	368 0.707					350 0.653	72 0.112	0.204 0.171
23	322 0.218	366 0.242	350 0.230	286 0.183							331 0.218	35 0.025	0.106 0.116
24	320 0.770	433 0.700	392 0.699	426 0.735	383 0.670	458 0.790					402 0.727	49 0.046	0.121 0.063
25	517 0.202	530 0.166	868 0.186	593 0.202	617 0.228	555 0.175	733 0.244				630 0.200	127 0.028	0.202 0.140
26	901 0.317	973 0.409	1057 0.420	1098 0.480							1007 0.406	88 0.067	0.087 0.166

For SI: 1 inch = 25.4 mm, 1lb = 4.448 N

SHEAR TEST – LOAD DISPLACEMENT CURVES

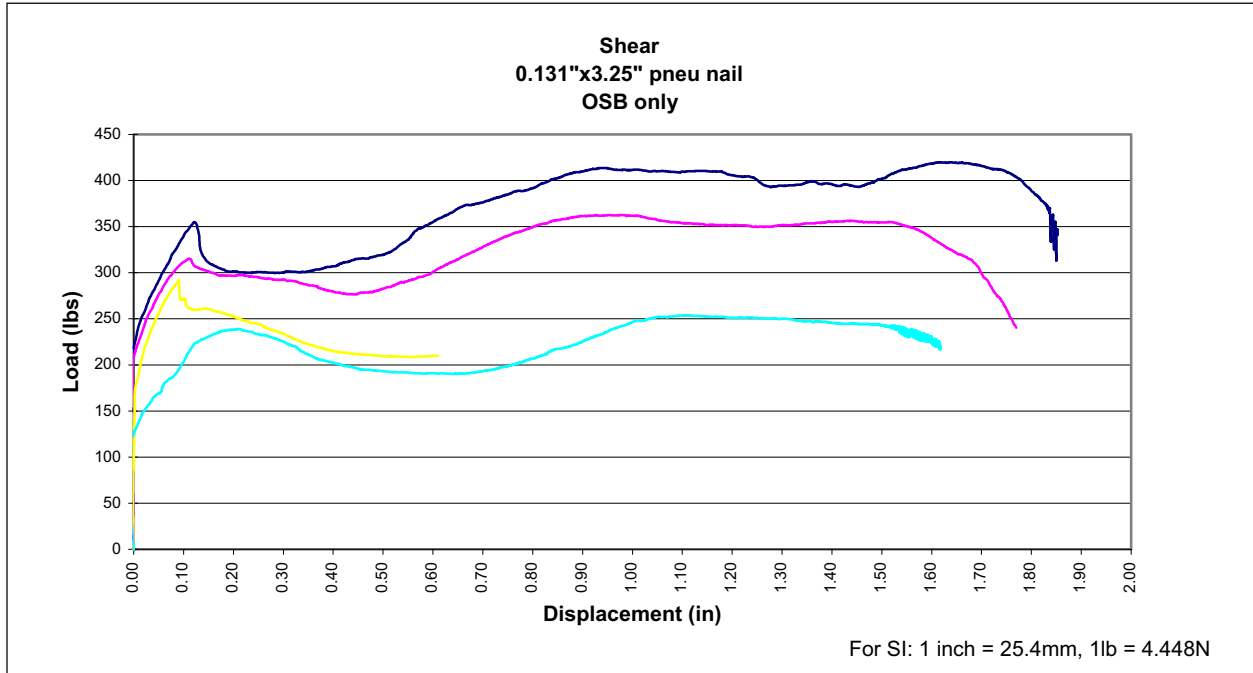

TEST SET #1

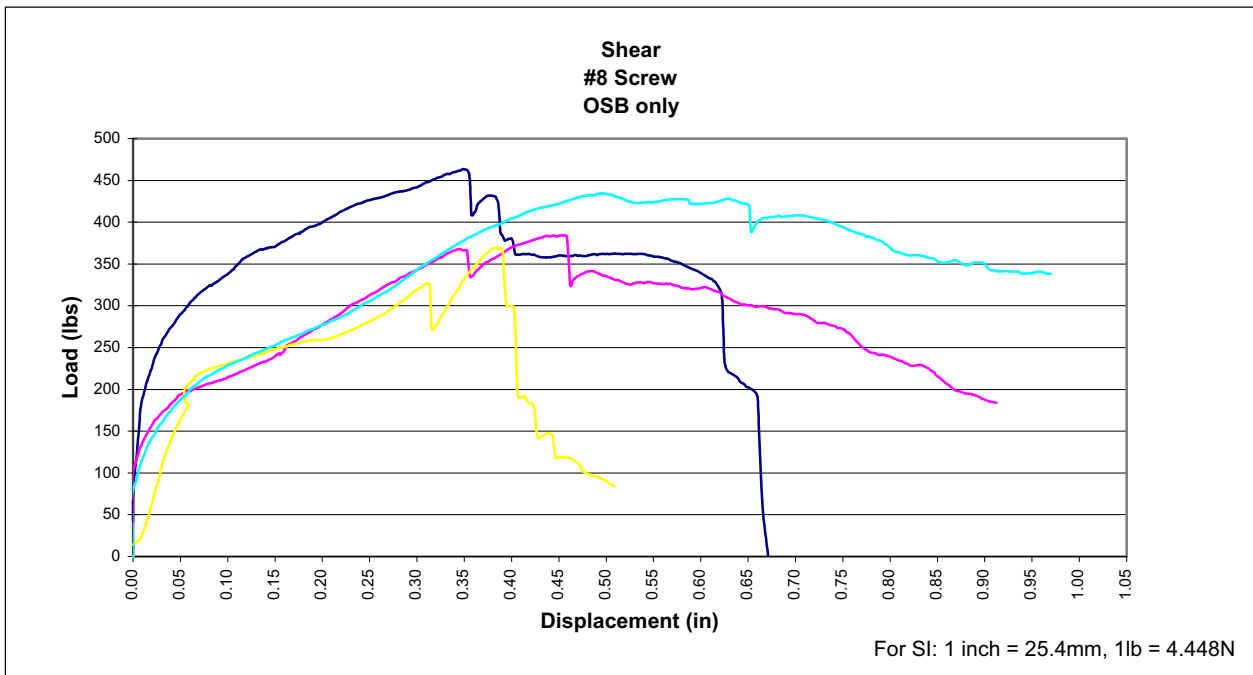

TEST SET #2

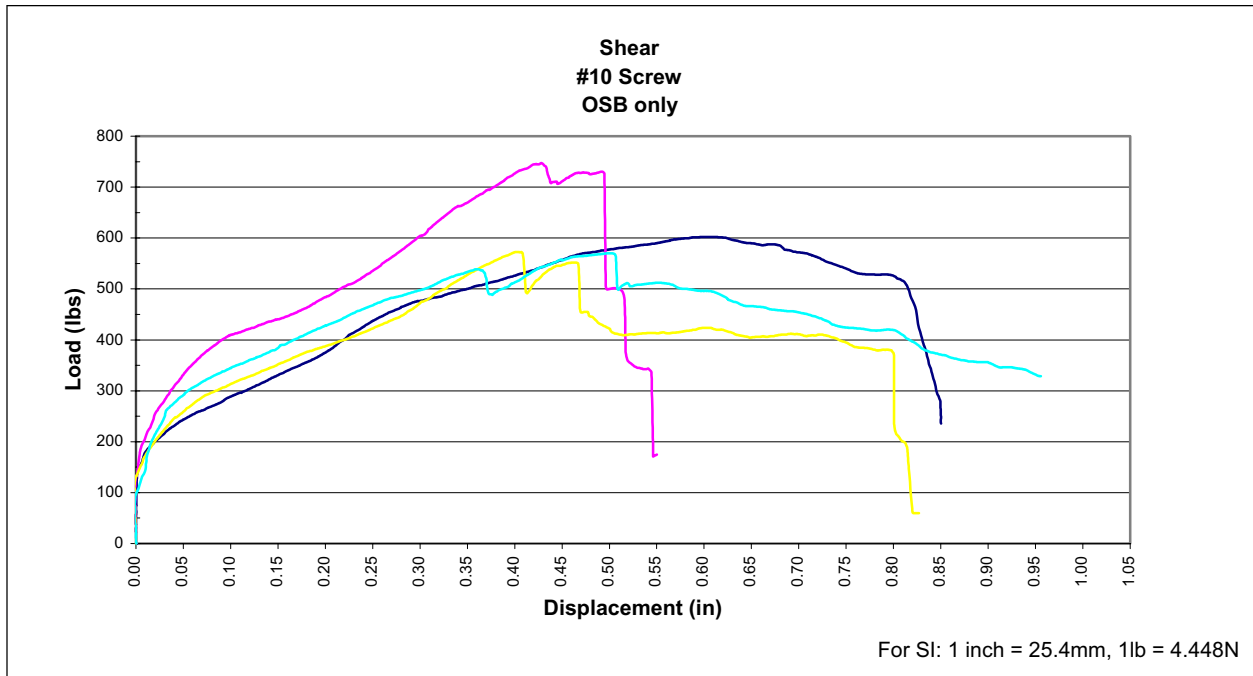

TEST SET #3

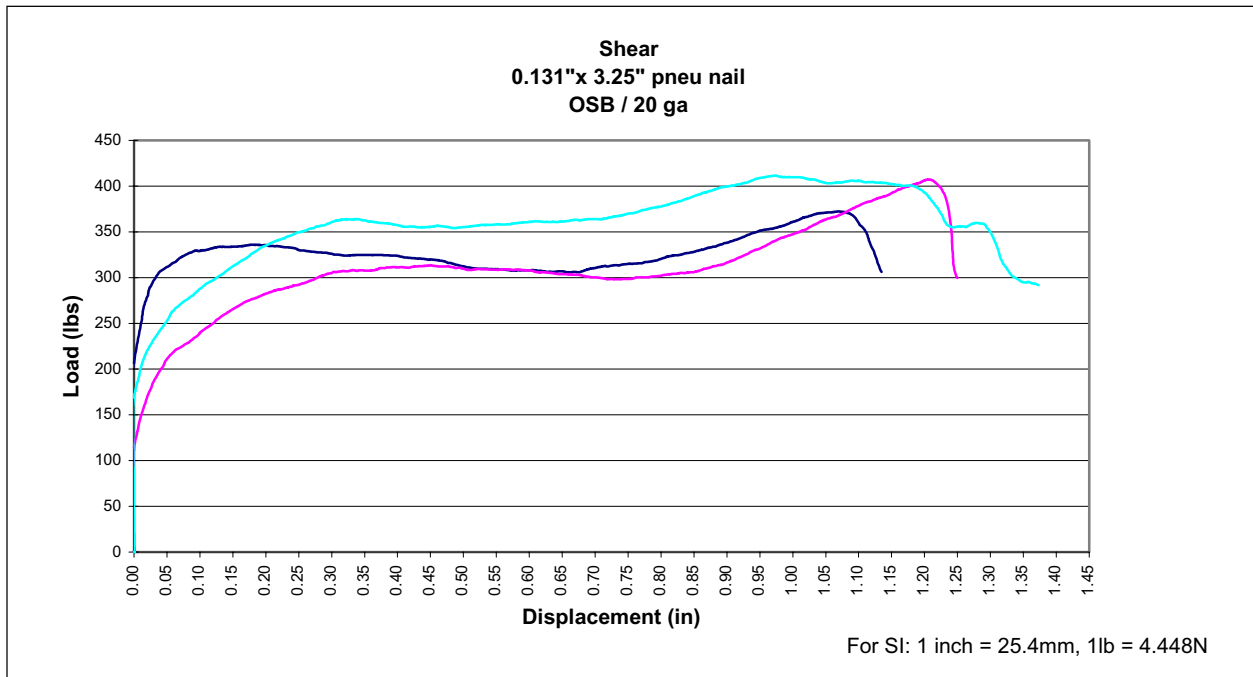

TEST SET #4

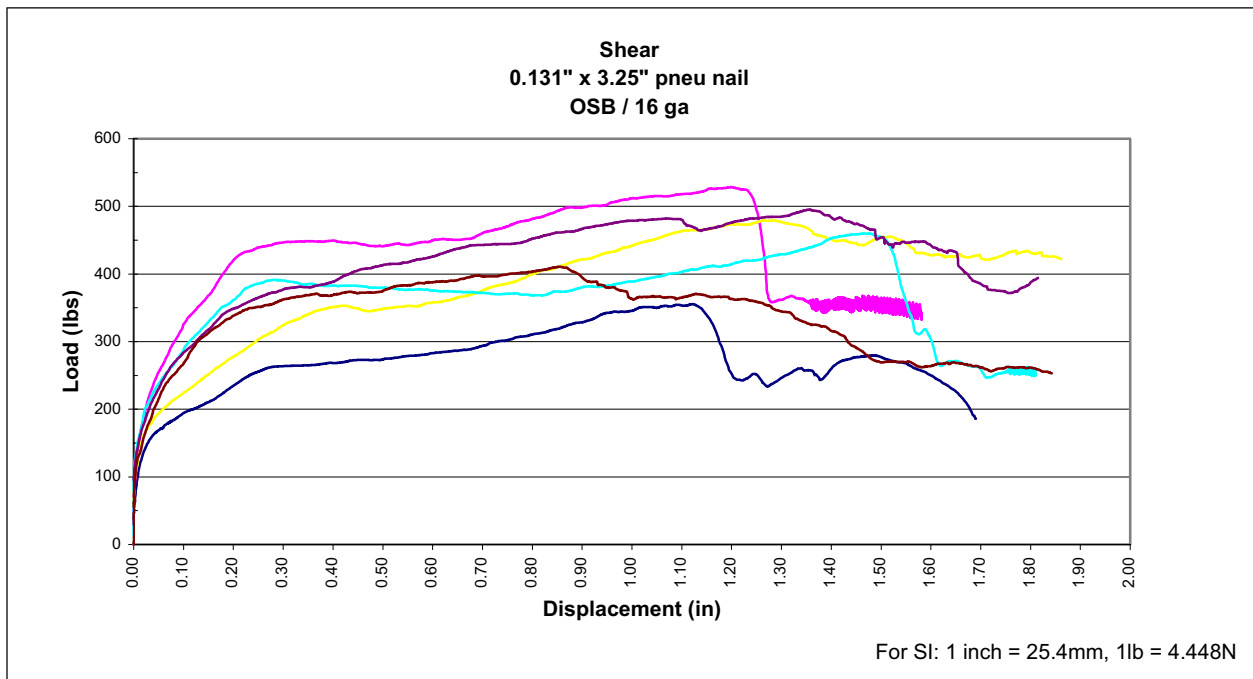
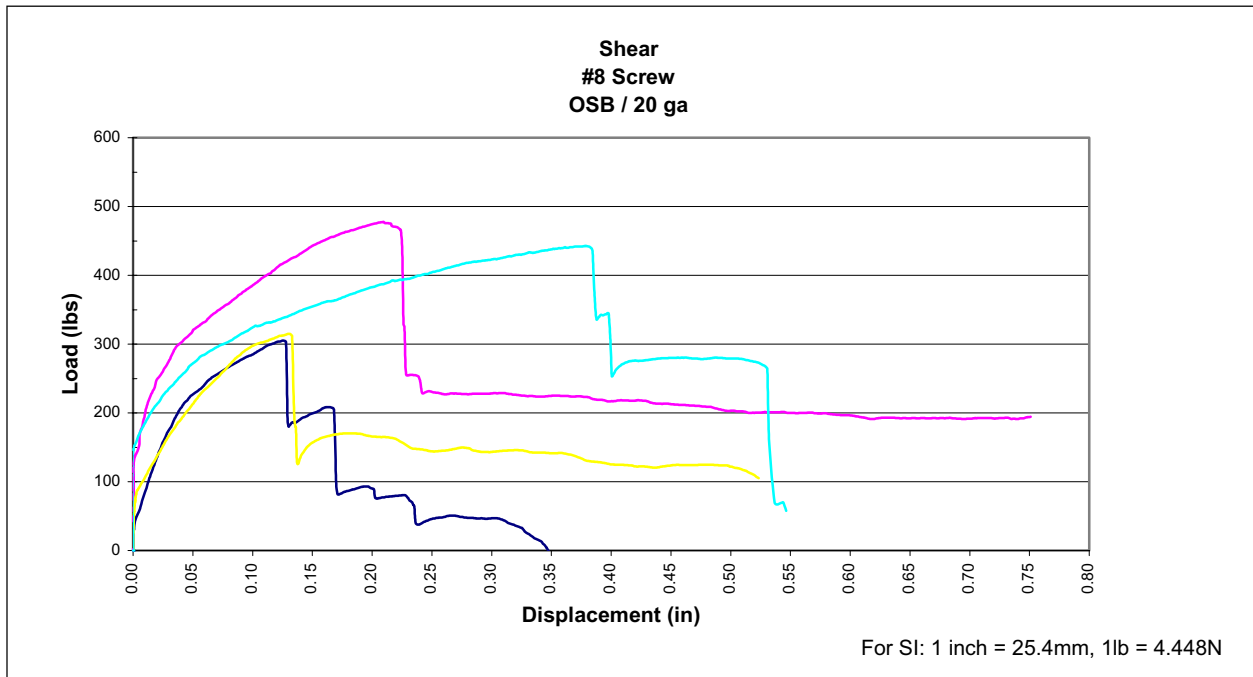

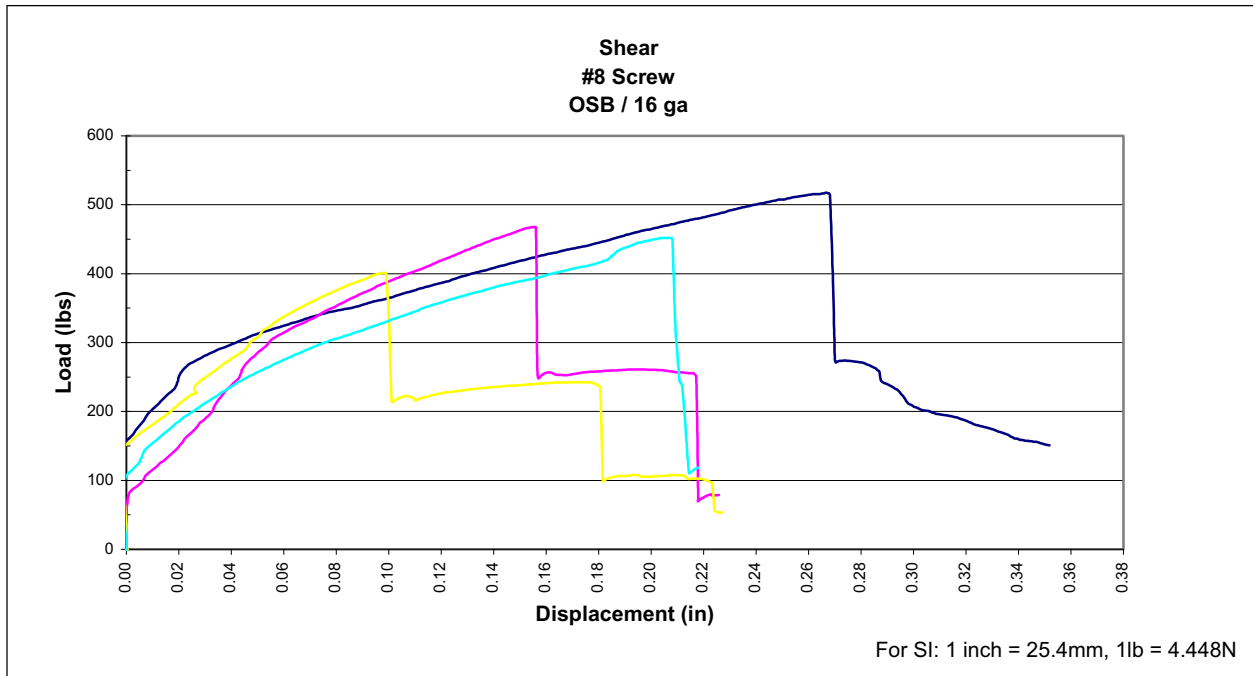

TEST SET #7

STEEL-TO-WOOD TESTS

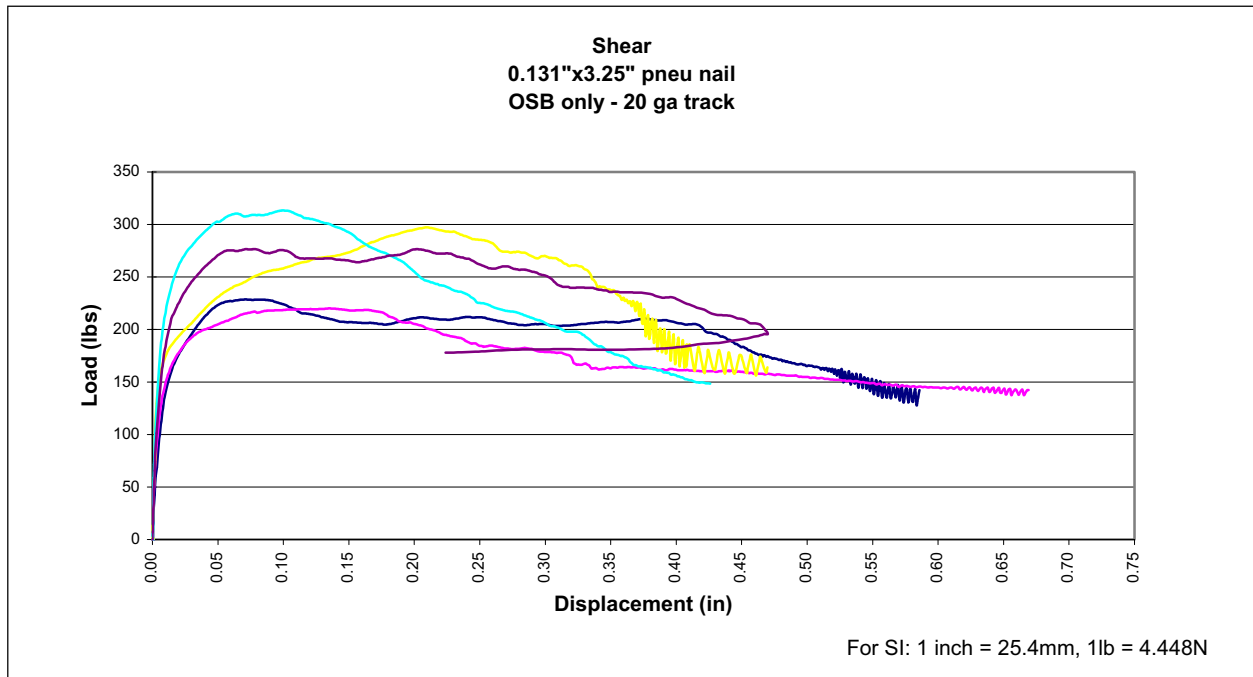

TEST SET #15

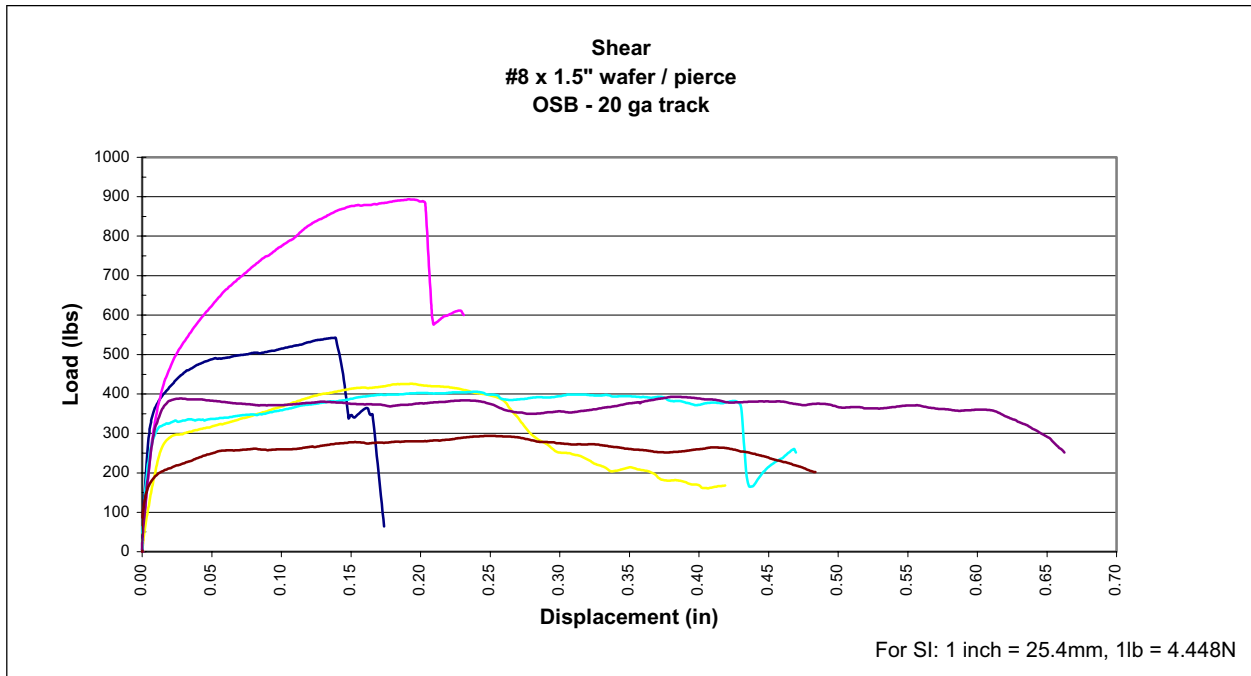

TEST SET #16

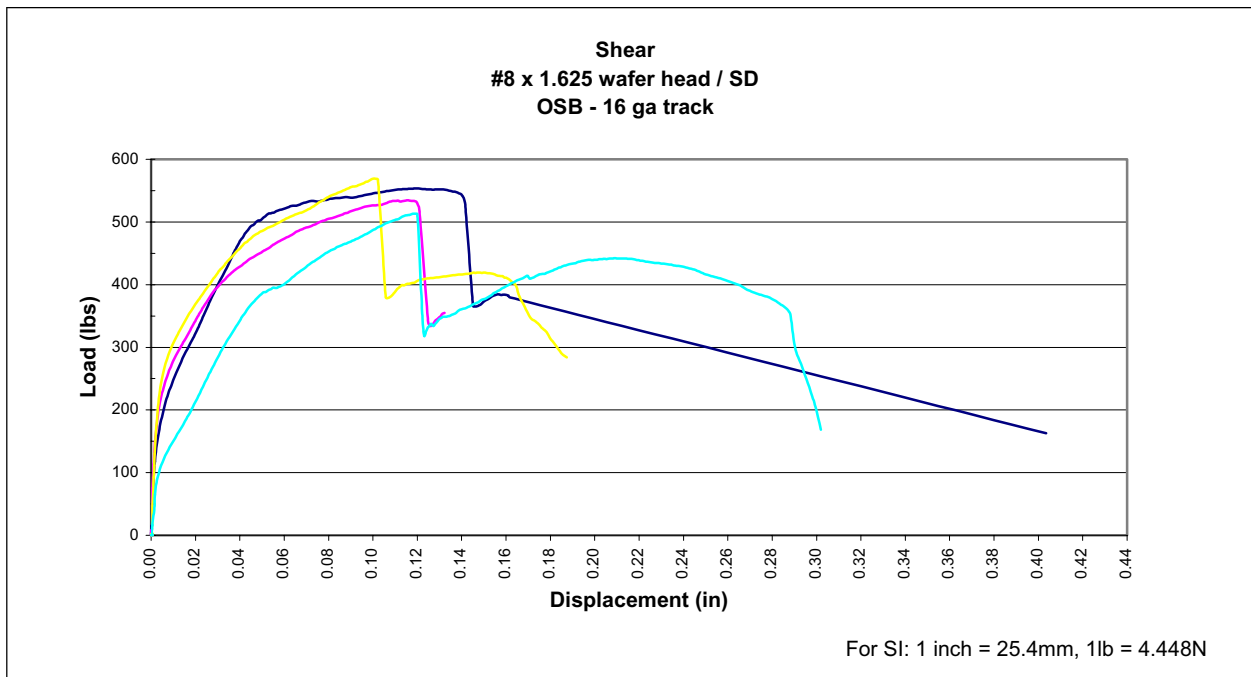

TEST SET #17

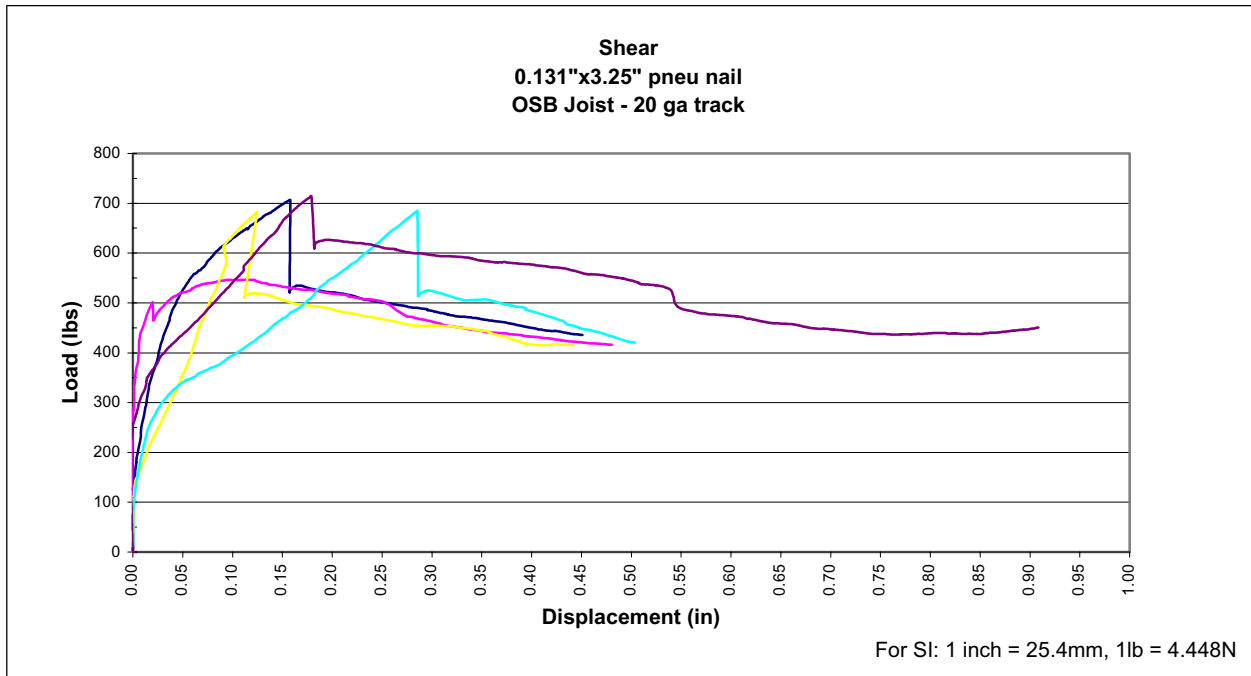

TEST SET #18

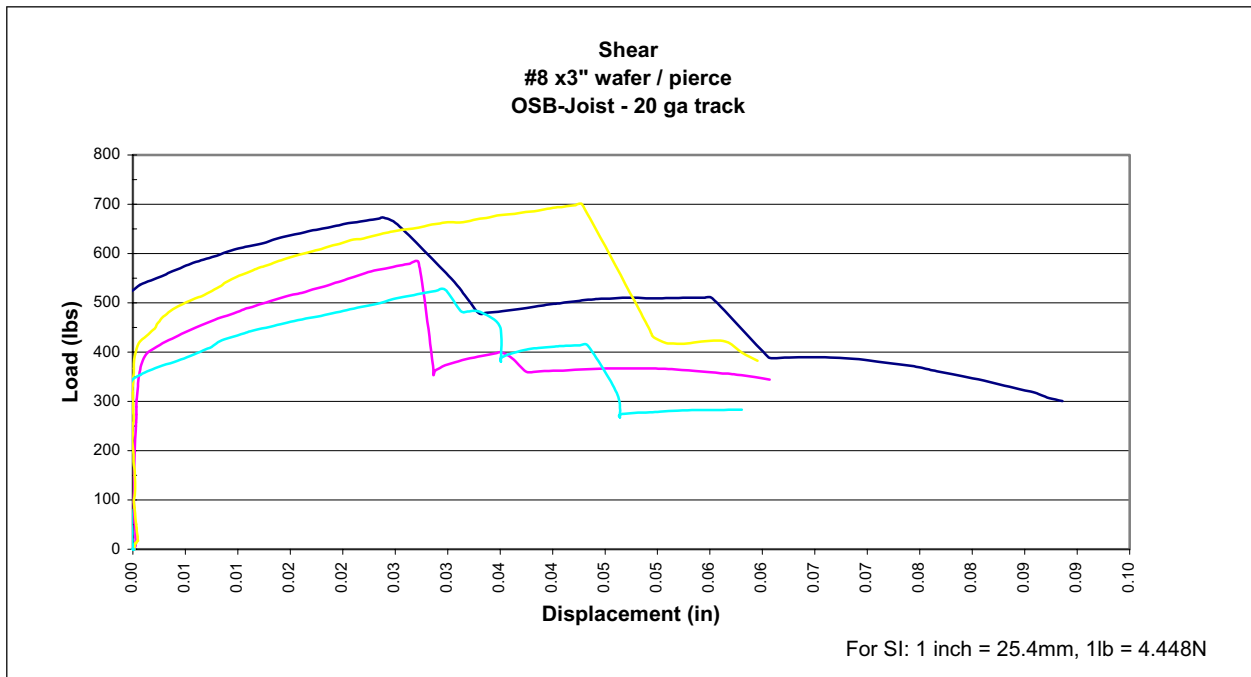

TEST SET #19

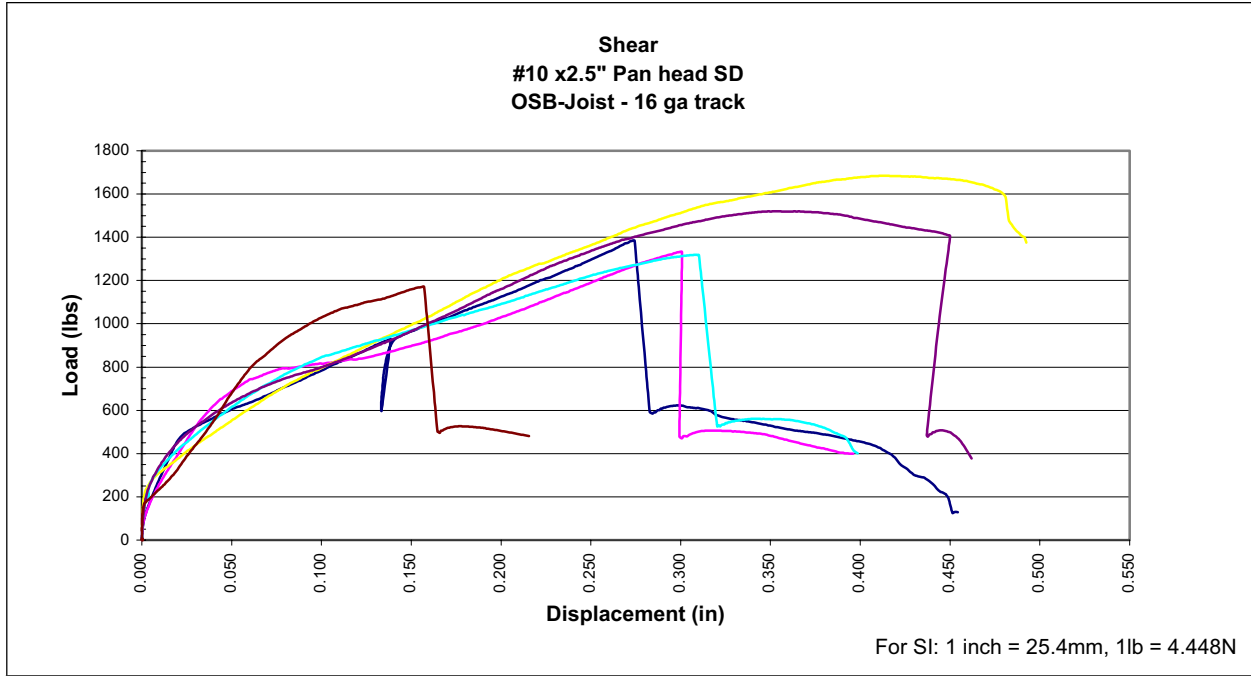

TEST SET #20

APPENDIX B

FACTOR OF SAFETY

Ω = Factor of safety Resistance Factor

$$\Omega = \frac{1.6}{\phi} \quad \phi = C_{\phi} (M_m F_m P_m) e^{-\beta_0 \sqrt{V_M^2 + V_F^2 + C_P V_P^2 + V_Q^2}}$$

(Refer to text for all variables)

CALCULATED FACTOR OF SAFETY FOR SHEAR TESTS

TEST SET	FASTENER	# TESTS	COV	RES. FACT	SF
1	0.131" x 3.25" pneumatic nail - bright	4	0.222	0.279	5.73
2	#8 x 3" self-tapping, flat head, screw	4	0.106	0.501	3.20
3	#10 x 3" self-tapping, flat head, screw	4	0.135	0.441	3.63
4	0.131" x 3.25" pneumatic nail - bright	4	0.066	0.575	2.78
5	#8 x 3" self-drilling, bugle head, screw	4	0.228	0.270	5.93
6	0.131" x 3.25" pneumatic nail - bright	6	0.137	0.515	3.11
7	#8 x 3" self-drilling, bugle head, screw	4	0.104	0.505	3.17
15	0.131" x 3.25" pneumatic nail - bright	6	0.138	0.514	3.11
16	#8 x 1.5" self-piercing, wafer head, screw	5	0.215	0.367	4.36
17	#8 x 1-5/8" self-drilling, wafer head, screw	4	0.045	0.606	2.64
18	0.131" x 3.25" pneumatic nail - bright	5	0.103	0.547	2.93
19	#8 x 3" self-piercing, wafer head, screw	4	0.129	0.453	3.53
20	#10 x 2.5" self-drilling, pan head, screw	6	0.127	0.529	3.02
AVG					3.63

LATERAL FORCE CALCULATIONS

Assume:	Ref.
Exposure B	[1]
$K_Z = 0.75$	[1]
$K_D = 0.85$	[1]
Lateral Pressure Coefficient for walls = 1.1	[4]
 <i>Velocity Pressure = 0.00256K_D K_Z V²</i>	 [5]

WIND SPEED CATEGORIES	VELOCITY PRESSURE
Up to 90 mph	13 psf
Up to 110 mph	19 psf
Up to 140 mph	31 psf

For SI: 1 mph = 1.60934 km/hr, 1 psf = 47.88 Pa

LOAD ON CONNECTION

Tributary Height (TH)	Velocity Pressure (VP)	Lateral Pressure Coefficient (LPC)	Transverse load at wall-to-floor interface (TH x VP x LPC)
5'	13 psf	1.1	71.5 plf
5'	19 psf	1.1	104.5 plf
5'	31 psf	1.1	165.0 plf

For SI: 1 psf = 47.88 Pa, 1 plf = 1.488 kg/m

CONNECTION REQUIREMENT

Fastener Schedule (o.c. spacing) = Fastener design value / Transverse load

EXAMPLE

Determine the fastener schedule for the connection of a wood wall to 20-gauge steel floor system using 0.131” x 3.25” pneumatic nails. Wind Speed = 90 mph.

Average ultimate shear strength of nail = 387.6 lbs (1724 N)

Design strength = 387.6 / 3.6 = 107.6 lbs (479 N)

Fastener Schedule = (107.6 lbs / 104.5 plf) x (12” / 1 ft) = 12.36 inches on center (314 mm)

Since studs are typically 16” on center in wood wall construction,

Use (2) nails every 16 – inches (406 mm) (nails are to be driven into joist or rim)

Note: The same fastening schedule would have been required for connection to the OSB sheathing only. Therefore, the connection can be made using (2) nails every 16-inches (406 mm) without hitting the joist or rim. The uplift requirements should be checked for the specific building assembly. (OSB and Joist = 42 lbs uplift / fastener, OSB only = 24 lbs uplift / fastener.)



American Iron and Steel Institute

1140 Connecticut Avenue, NW
Suite 705
Washington, DC 20036
www.steel.org



Steel Framing Alliance™

Steel. The Better Builder.

1201 15th Street, NW
Suite 320
Washington, DC 20005
www.steel framing.org

